



The Bose® Lifestyle® 40 Music System

Owner's Guide

December 20, 2001

AM189858_03_V.pdf

 **WARNING:** To reduce the risk of fire or electric shock, do not expose the system to rain or moisture.

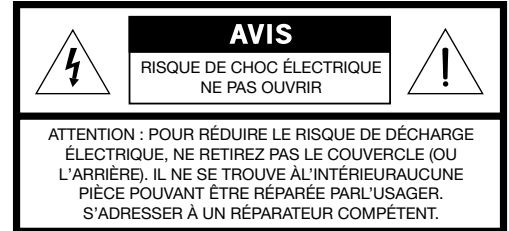
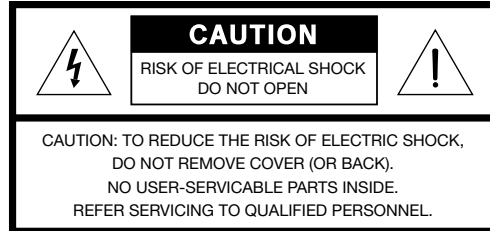

These CAUTION marks are located on the bottoms of your Lifestyle® Personal™ music center, Acoustimass® module, multi-room interface, and CD changer:

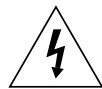

The lightning flash with arrowhead symbol, within an equilateral triangle, is intended to alert the user to the presence of uninsulated dangerous voltage within the system enclosure that may be of sufficient magnitude to constitute a risk of electric shock.





The exclamation point within an equilateral triangle, as marked on the system, is intended to alert the user to the presence of important operating and maintenance instructions in this owner's guide.

 **CAUTION:** To prevent electric shock, match wide blade of plug to wide slot, insert fully.

Class 1 laser product

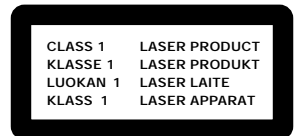
This compact disc player is classified as a CLASS 1 LASER PRODUCT. The CLASS 1 LASER PRODUCT label is located on the bottom of the unit.



 **CAUTION:** Use of controls or adjustments or performance of procedures other than those specified herein may result in hazardous radiation exposure. The compact disc player should not be adjusted or repaired by anyone except properly qualified service personnel.

Class B emissions limits

This Class B digital apparatus meets all requirements of the Canadian Interference-Causing Equipment Regulations.

Batteries

Please dispose of used batteries properly, following any local regulations. Do not incinerate.

Additional safety information

See the additional instructions on the *Important Safety Information* page enclosed with this owner's guide.

Please read this owner's guide

Please take the time to follow this owner's guide carefully. It will help you set up and operate your system properly, and enjoy all of its advanced features. Save your owner's guide for future reference.

1. **Read these instructions** – for all components before using this product.
2. **Keep these instructions** – for future reference.
3. **Heed all warnings** – on the product and in the owner's guide.
4. **Follow all instructions.**
5. **Do not use this apparatus near water or moisture** – Do not use this product near a bathtub, washbowl, kitchen sink, laundry tub, in a wet basement, near a swimming pool, or anywhere else that water or moisture are present.
6. **Clean only with a dry cloth** – and as directed by Bose® Corporation. Unplug this product from the wall outlet before cleaning.
7. **Do not block any ventilation openings. Install in accordance with the manufacturer's instructions** – To ensure reliable operation of the product and to protect it from overheating, put the product in a position and location that will not interfere with its proper ventilation. For example, do not place the product on a bed, sofa, or similar surface that may block the ventilation openings. Do not put it in a built-in system, such as a bookcase or a cabinet that may keep air from flowing through its ventilation openings.
8. **Do not install near any heat sources, such as radiators, heat registers, stoves or other apparatus (including amplifiers) that produce heat.**
9. **Do not defeat the safety purpose of the polarized or grounding-type plug. A polarized plug has two blades with one wider than the other. A grounding-type plug has two blades and a third grounding prong. The wider blade or third prong are provided for your safety. If the provided plug does not fit in your outlet, consult an electrician for replacement of the obsolete outlet.**
10. **Protect the power cord from being walked on or pinched, particularly at plugs, convenience receptacles, and the point where they exit from the apparatus.**
11. **Only use attachments/accessories specified by the manufacturer.**
12. **Use only with the cart, stand, tripod, bracket or table specified by the manufacturer or sold with the apparatus. When a cart is used, use caution when moving the cart/apparatus combination to avoid injury from tip-over.**
13. **Unplug this apparatus during lightning storms or when unused for long periods of time** – to prevent damage to this product.
14. **Refer all servicing to qualified service personnel. Servicing is required when the apparatus has been damaged in any way: such as power-supply cord or plug is damaged; liquid has been spilled or objects have fallen into the apparatus; the apparatus has been exposed to rain or moisture, does not operate normally, or has been dropped** – Do not attempt to service this product yourself. Opening or removing covers may expose you to dangerous voltages or other hazards. Please call Bose to be referred to an authorized service center near you.
15. **To prevent risk of fire or electric shock, avoid overloading wall outlets, extension cords, or integral convenience receptacles.**
16. **Do not let objects or liquids enter the product** – as they may touch dangerous voltage points or short-out parts that could result in a fire or electric shock.
17. **See product enclosure for safety related markings.**



Information about products that generate electrical noise

If applicable, this equipment has been tested and found to comply with the limits for a Class B digital device, pursuant to Part 15 of the FCC rules. These limits are designed to provide reasonable protection against harmful interference in a residential installation. This equipment generates, uses, and can radiate radio frequency energy and, if not installed and used in accordance with the instructions, may cause harmful interference to radio communications. However, this is no guarantee that interference will not occur in a particular installation. If this equipment does cause harmful interference to radio or television reception, which can be determined by turning the equipment off and on, you are encouraged to try to correct the interference by one or more of the following measures:

- Reorient or relocate the receiving antenna.
- Increase the separation between the equipment and receiver.
- Connect the equipment to an outlet on a different circuit than the one to which the receiver is connected.
- Consult the dealer or an experienced radio/TV technician for help.

Note: Unauthorized modification of the receiver or radio remote control could void the user's authority to operate this equipment.

This product complies with the Canadian ICES-003 Class B specifications.

18. **Use proper power sources** – Plug the product into a proper power source, as described in the operating instructions or as marked on the product.
19. **Avoid power lines** – Use extreme care when installing an outside antenna system to keep from touching power lines or circuits, as contact with them may be fatal. Do not install external antennas near overhead power lines or other electric light or power circuits, nor where an antenna can fall into such circuits or power lines.
20. **Ground all outdoor antennas** – If an external antenna or cable system is connected to this product, be sure the antenna or cable system is grounded. This will provide some protection against voltage surges and built-up static charges.
Section 810 of the National Electrical Code ANSI/NFPA No. 70 provides information with respect to proper grounding of the mast and supporting structure, grounding of the lead-in wire to an antenna discharge unit, size of grounding conductors, location of antenna-discharge unit, connection to grounding electrodes, and requirements for the ground electrode. Refer to the antenna grounding illustration on this page.

Antenna grounding

Example of antenna grounding as per National Electrical Code, ANSI/NFPA 70.

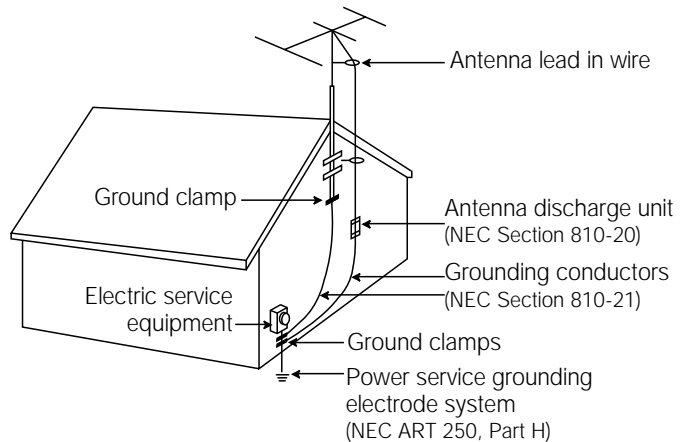

Note to CATV system installer

This reminder is provided to call the CATV system installer's attention to Article 820-40 of the NEC (of USA) that provides guidelines for proper grounding. In particular, it specifies that the cable ground shall be connected to the grounding system of the building, as close to the point of cable entry as is practical.

Where to find ...

Setting Up 4
 Before you begin 4
 Unpacking the carton 5
 Selecting the locations for your Lifestyle® 40 music system 6
 Connecting your system 8
 Connecting external components 11
 Connecting the antennas 12
 Completing connections and turning on the Acoustimass® module 13
 Setting up the Personal™ music center 13
 Operating Your Lifestyle® 40 Music System 14
 Turning on the system 14
 Using the Personal music center display 16
 Listening to the radio 18
 Listening to compact discs 21
 Using the system with external components 27
 Fine-tuning your system 28
 Operating a Multi-Room Lifestyle® 40 Music System 32
 Connecting additional rooms 32
 Operating in more than one room 33
 Using more than one Personal music center 35
 Maintaining Your Lifestyle® 40 Music System 36
 Finding a misplaced Personal music center 36
 Replacing batteries 36
 Cleaning the system 37
 Troubleshooting 38
 Warranty period 39
 Customer service 39
 Product Information 40
 Technical information 40
 Accessories 40
 Index 41
 Bose® Corporation Inside back cover

For your records

Serial numbers are located on the bottom panels of the Personal music center, multi-room interface, CD changer, and the Acoustimass® module.

Personal music center serial number: _____

Multi-room interface serial number: _____

CD changer serial number: _____

Acoustimass module serial number: _____

Dealer name: _____

Dealer phone: _____ Purchase date: _____

We suggest you keep your sales slip and warranty card together with this owner's guide.

Before you begin

Thank you for purchasing the Bose® Lifestyle® 40 music system. Years of research lie behind this complete audio home entertainment system – the most advanced compact music system available from Bose. Technological innovations that make the Lifestyle® 40 music system unique include the Bose Personal™ music center, which places all system operations in the palm of your hand, and tiny Jewel Cube® speakers so small they virtually disappear.

The Personal music center is a clear departure from convention – it's interactive, sending out and receiving signals from the system, so you can control all the advanced features as you move about your home. Communicating through its two-way radio frequency link, the Personal music center keeps you informed of the system's status, facilitating full control of its operations.

The Bose Jewel Cube® speakers are also far from conventional. Proprietary technologies ensure that these tiny speakers not only fill a room with sound, but also reproduce sound more accurately than traditionally designed loudspeakers.

The other elements of the Lifestyle® 40 music system are designed to be hidden from view:

- The elegant Lifestyle® CD changer, designed to give you flexibility in where it is placed
- The hideaway powered Acoustimass® module that delivers the rich, full, lifelike bass
- The Bose multi-room interface, including a built-in AM/FM tuner, inputs for two video sources, an auxiliary source, and tape deck. In addition, it has four independent audio outputs that allow you to enjoy Bose sound throughout your home.

These, and numerous other innovations, bring you the Lifestyle® 40 system, offering superb sound, elegance, and simplicity for music and home entertainment.

Please take the time to read this owner's guide carefully. It will help you set up and operate your Lifestyle® system, and enjoy all its advanced features. Please save the owner's guide for future reference.

Unpacking the carton

Carefully unpack your system. Save all packing materials for possible future use. The original packing materials provide the safest way to transport your Lifestyle[®] 40 music system. If any part of the product appears damaged, do not attempt to use the system. Notify Bose[®] or your authorized Bose dealer immediately.

Check to be sure your Lifestyle[®] 40 music system contains the parts identified in Figure 1.

 **Note:** Find the serial numbers on the bottom panels of the Personal[™] music center, multi-room interface, CD changer, and Acoustimass[®] module. Then write them on your warranty card and in the spaces provided on page 3.

 **CAUTION:** Be sure the three shipping screws on the bottom of the CD changer have been removed before setting up the system.

 **WARNING:** The Acoustimass module weighs 33 pounds (15 kg). Use good lifting practice to avoid injury.

 **WARNING:** To avoid danger of suffocation, keep the plastic bags out of the reach of children.

Figure 1

What comes with your Lifestyle[®] 40 system:

- Personal music center
- CD changer
- Multi-room interface
- Interface power pack*
- 2 Jewel Cube[®] speakers
- 2 speaker cables
- Acoustimass module
- AC power (mains) cord*
- 8 self-adhesive rubber feet (4 for the module and 2 pairs for the Jewel Cube speakers)
- Audio input cable
- CD changer cable
- 4 AAA batteries
- FM antenna
- AM loop antenna
- AM antenna base
- CD magazine
- Lifestyle[®] system CD

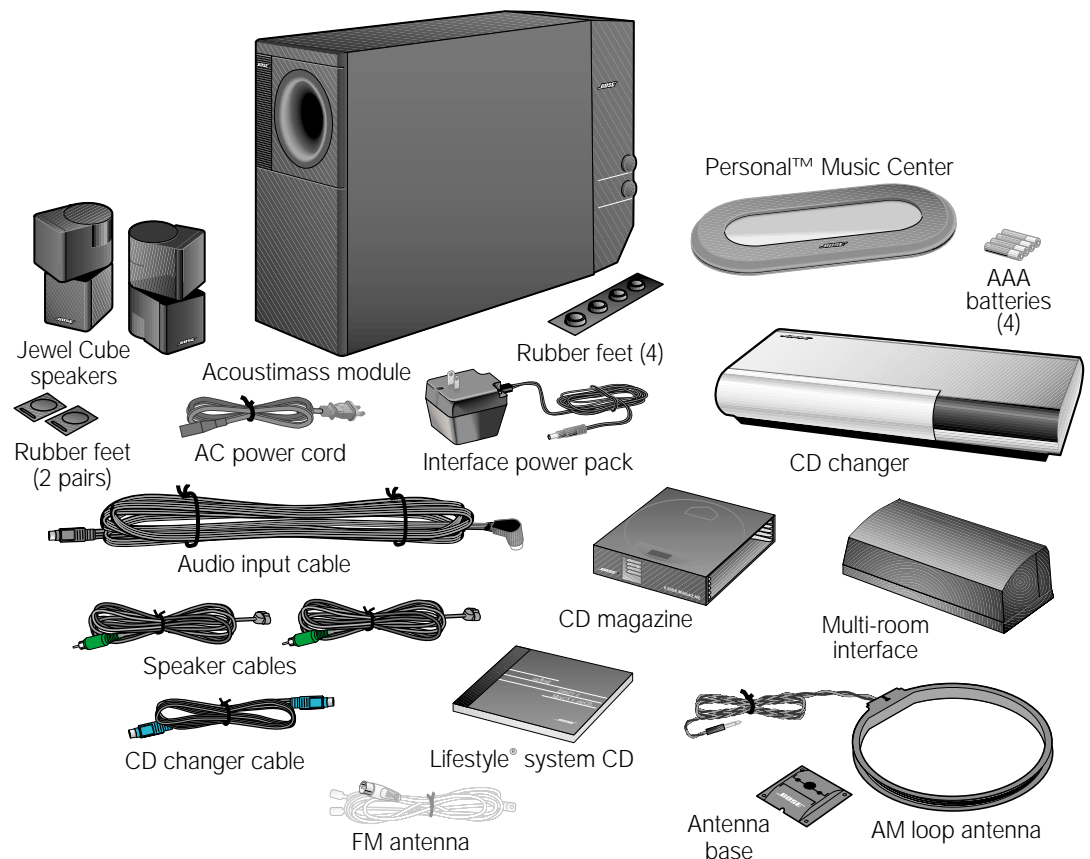

* Power cord and pack shown above are USA/Canada/Japan versions. Dual voltage systems include 1 power cord, 1 adapter , and 2 power packs. The power cords and packs for Europe, UK/Singapore, and Australia are shown below.

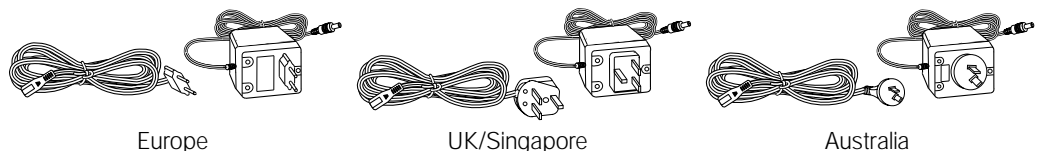

Selecting the locations for your Lifestyle® 40 music system

When you place your speakers according to the guidelines below, a combination of reflected and direct sound provides a lifelike stereo image virtually everywhere in the room. You may experiment with the placement and orientation of the Jewel Cube® speakers and Acousti-mass® module to produce the sound most pleasing to you.

For more discussion of speaker placement and room acoustics, see “Fine-tuning your system” on page 28.

Jewel Cube speakers

Follow these guidelines to select locations that provide the maximum stereo effect from your Lifestyle® 40 music system (Figure 2).

1. For the most lifelike sound, place the Jewel Cube speakers 6-12 feet (1.8-3.6 m) apart. They can be as close as 3 feet (1 m) or as far apart as 15 feet (4.6 m).
2. Place the Jewel Cube speakers 6-12 inches (15-30 cm) from the surface behind them.
3. Direct one cube of each speaker toward the center of the room. Direct the other cube toward a side wall to create reflected sound.

⚠ CAUTION: Choose a stable and level surface for your Jewel Cube speakers. Vibration can cause the speakers to move, particularly on very smooth surfaces. For stability, peel off the backing from the two identical rubber feet and center them in the matching shapes on the bottom of each speaker.

🎵 Note: The Jewel Cube speakers are magnetically shielded so you can place them close to the TV without affecting picture quality.

🎵 Note: If you put the speakers in a bookcase unit, be sure to place each one at the front edge of the shelf. Placing speakers in an enclosed space can change the tonal quality of the sound. This effect is minimized if the shelves are filled with books.

Figure 2

Recommended speaker locations

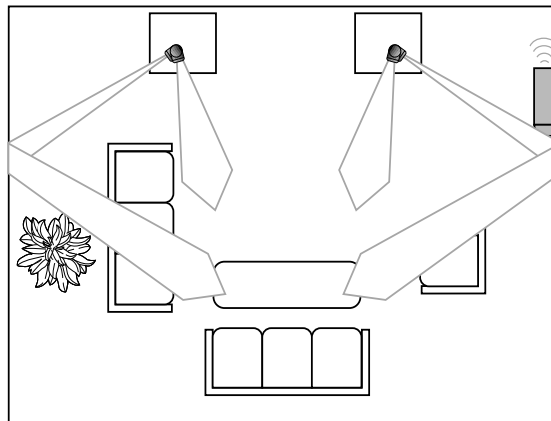

Acoustimass® module

Follow these guidelines to select a location for the Acoustimass module.

♪ *Note: To avoid interference with the TV picture, place the Acoustimass module at least 18 inches (45 cm) from the TV.*

1. Place the Acoustimass module along the same wall or close to the same end of the room as the Jewel Cube® speakers. See the example in Figure 2.
2. Select a convenient location – under a table, behind a sofa. Do not allow furniture or drapes to block the ventilation openings of the module.
3. Place the Acoustimass module within reach of the audio input cable, speaker cables, and an AC power (mains) outlet.
4. Select a position for the Acoustimass module (Figure 3). For proper ventilation, place it on the long edge, with the connectors facing the floor. An alternate position is on its largest side, with the bass and treble controls facing up. Do not place the module on either end, as shown by the last two views in Figure 3.

Figure 3

Acoustimass module positions

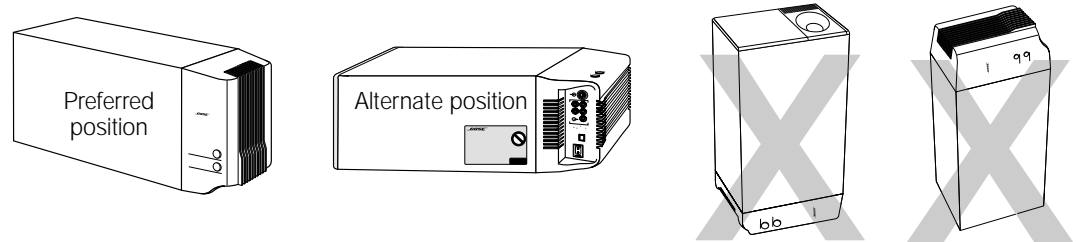

5. Once you have selected a position for the module, place the four self-adhesive rubber feet near the corners of the bottom surface. The rubber feet provide increased stability and protection from scratches.
6. Aim the port (the round opening) into the room or along the wall to avoid blocking the port or creating too much bass.
7. For best bass performance, do not place the port at equal distances from any two walls or from a wall and the ceiling.

⚠ **CAUTION:** Do not cover the ventilation openings of the Acoustimass module. The slots on the end provide ventilation for the built-in electronic circuitry, and should not be blocked.

⚠ **CAUTION:** The magnetic field from the Acoustimass module is not an immediate risk to your video tapes, audio tapes, and other magnetic media. However, you should not store tapes directly on or near the Acoustimass module.

Multi-room interface

Select a location for the multi-room interface. It may be placed out of sight, if you like.

1. Place the multi-room interface within 30 feet (9.1 m) of the Acoustimass module (the length of the audio input cable).
2. Place the multi-room interface close enough to the sound sources (TV, VCR, DVD, etc.) to allow for cable length. If you need additional audio and/or video cables to connect all of your components, see your dealer or call Bose® Customer Service.

CD changer

Select a convenient location for the CD changer.

1. Place the CD changer on a level surface. Allow enough room to lift the door.
2. Place the CD changer close enough to the multi-room interface to allow for a cable length of 6 feet (2 m).

Figure 4

Multi-room interface

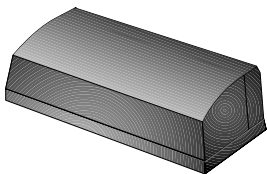

Figure 5

CD changer



Connecting your system

Once you have selected locations for your speakers, CD changer, and interface, connect the system.



CAUTION: Make sure all components are unplugged from the power outlet before you begin hooking up the system.

Connecting the Jewel Cube® speakers to the Acoustimass® module

1. Insert the connector of each speaker cable fully into the jack on the rear of each speaker (Figure 6). Match the ridge of the connector to the notch at the top of the jack.
2. Connect each 20-foot (6.1 m) cable to the corresponding left or right green jack on the Acoustimass module. Speaker cables have green connectors at one end, with L (left) and R (right) molded into the connectors.

To lengthen the cable, connect speaker wire with male phono (RCA) plugs on each end to your supplied speaker cable. Use a female-to-female adapter ("barrel" connector). Or, splice in 18-gauge (.75 mm²) or thicker cord (connecting + to + and - to -). To purchase extension wire, see your dealer, electronics store, or call Bose® Customer Service.

Figure 6

Speaker cable connection to the Jewel Cube speaker

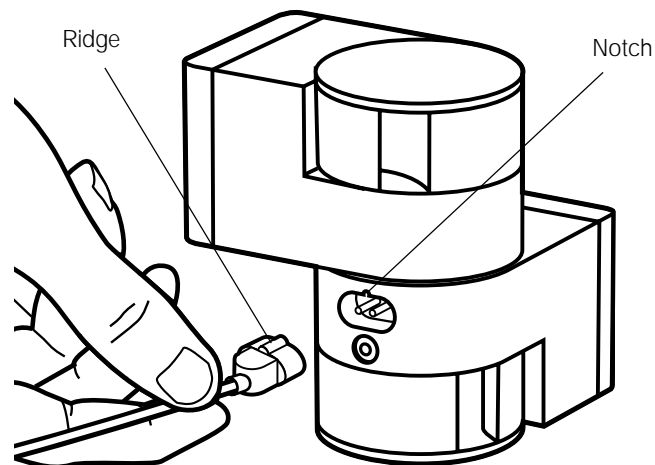

Connecting the Acoustimass® module to the multi-room interface

Connect the module to the interface with the audio input cable (Figure 7).

1. Insert the right-angle multi-pin connector on the audio input cable into the AUDIO INPUT jack on the module. Align the connector at the angle shown in Figure 7.
2. Plug the small black multi-pin connector (flat side facing up) into the jack marked ROOM A (PRIMARY) on the back of the interface.

♪ *Note: Be sure that each connector is inserted completely into each jack.*

For information on connecting multi-room systems, see “Connecting additional rooms” on page 32.

Connecting the CD changer to the multi-room interface

Connect the CD changer to the interface with the CD changer cable (Figure 7).

1. Plug a blue multi-pin connector (flat side facing up) into the jack marked BOSE CD on the back of the interface.
2. Plug the other blue multi-pin connector (flat side facing left) into the jack marked BOSE CD on the back of the CD changer.

♪ *Note: Be sure that each connector is inserted completely into each jack.*

Figure 7

Speakers, CD changer, and multi-room interface connections

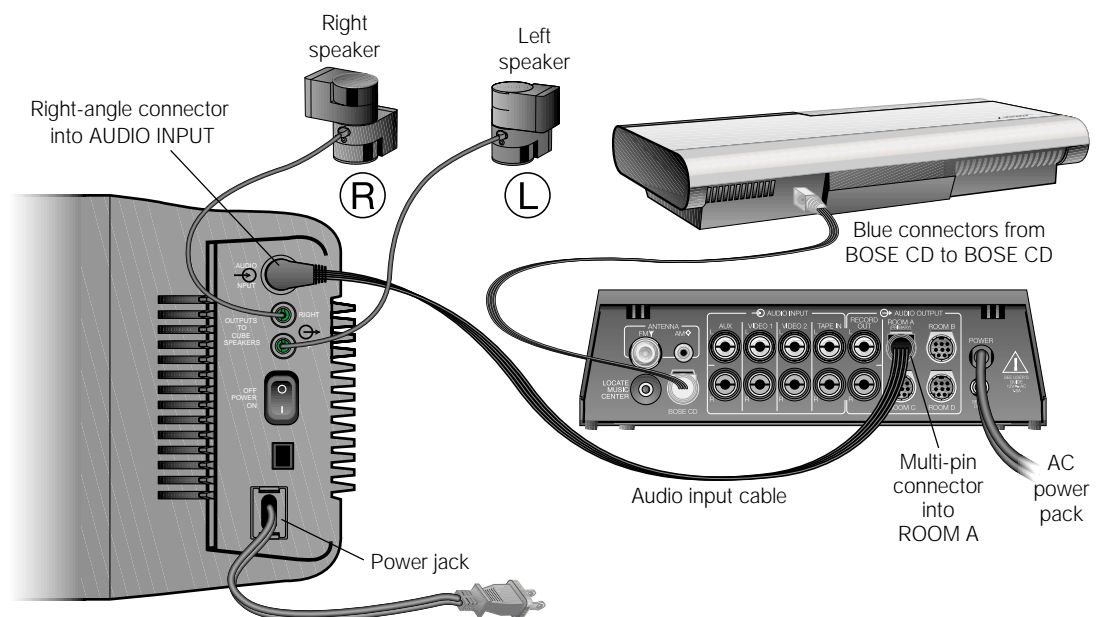

- ⚠** *Connecting the Acoustimass® module power (mains) cord*
CAUTION: If you have a dual-voltage system, make sure the voltage selector switch on the Acoustimass module is set correctly.
1. On a dual voltage system, the voltage selector switch is preset at the factory to be correct for your area. Check to be sure it is set for the proper voltage (Figure 8). Use 115V for North America; 230V for Europe and Australia. In Europe, use the adapter plug provided. If you are in doubt, contact your local electric utility for the appropriate voltage setting.
- 🎵** *Note:* Do not plug the AC power cord into a power outlet until all component connections are complete.
2. Plug the small end of the power (mains) cord into the Acoustimass module AC power jack.

Figure 8

Dual voltage Acoustimass module: voltage selector switch settings

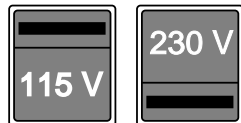

Connecting the multi-room interface power pack

The multi-room interface comes with either a 100V, 120V, 230V, or 240V power pack. See Figures 1 and 9. Dual voltage models include both the PS71 and PS72 power packs.

- ⚠** **CAUTION:** Be sure to use the correct Bose® power pack for your area. Using the wrong one may damage your power pack or your system.
- Model PS71, 120V in North America
 - Model PS72, 230V in Europe
 - Model PS73, 100V in Japan
 - Model PS74, 230V in UK or Singapore
 - Model PS77, 240V in Australia

Figure 9

The AC power pack (model PS71 shown)

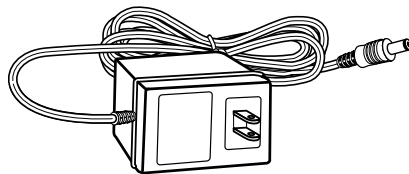

- 🎵** *Note:* Do not plug the power pack into a power outlet until you complete all component connections.
1. Firmly insert the small connector on the end of the power pack cable into the AC power jack on the back of the multi-room interface.
 2. Make sure that the power pack reaches an AC (mains) outlet.

Connecting external components

Use standard RCA audio cables to connect other components to your Lifestyle® system's multi-room interface, matching the red connector to R (right) and white (or black) connector to L (left).

You can use a Y-adaptor (available at electronics stores) to connect a mono source. However, the left and right speakers then play the same monaural sound.

Video components

To play video sound through your Lifestyle® music system, connect the R and L fixed audio outputs of your stereo VCR, stereo TV, or DVD player to the interface VIDEO 1 or 2 jacks. See Figure 10. You can use a Y-adaptor (available at electronics stores) to connect a mono source. However, the left and right speakers then play the same monaural sound.

Tape deck

To use an external tape recorder (analog audio cassette, analog open reel, digital audio tape, or Digital Compact Cassette), connect the inputs (REC) of the tape deck to the interface RECORD OUT jacks. Connect the outputs (PLAY) from the tape deck to the interface TAPE IN jacks. See Figure 10.

Laserdisc player or additional CD changer

To use one of these components, connect its audio outputs to the interface AUX jacks, matching the red plug to R (right) and black or white plug to L (left). See Figure 10.

Turntable

To connect a turntable, you need a phono preamplifier (with RIAA equalization). You can order the appropriate model (PN 252603) from Bose® Customer Service (See the inside back cover for locations and phone numbers.). Connect the audio outputs of the phono preamplifier to the interface AUX jacks, matching the red plug to R (right) and black or white plug to L (left).

♪ *Note: The Lifestyle® 40 music system cannot turn a connected component on or off.*

Figure 10

Connecting external components

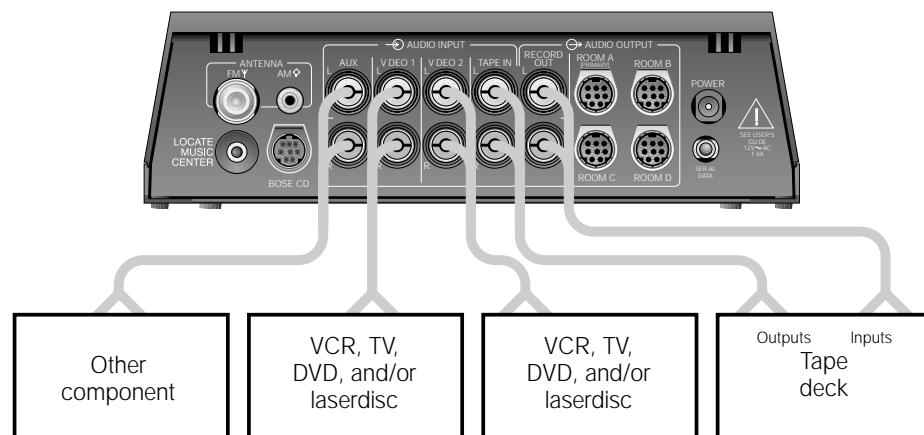

Connecting the antennas

The rear panel of your multi-room interface provides connections for the supplied AM and FM antennas (Figure 11). Untie and straighten the bundled wires on each antenna. Antennas provide better reception when their wires are fully extended.

Figure 11

The antenna connections

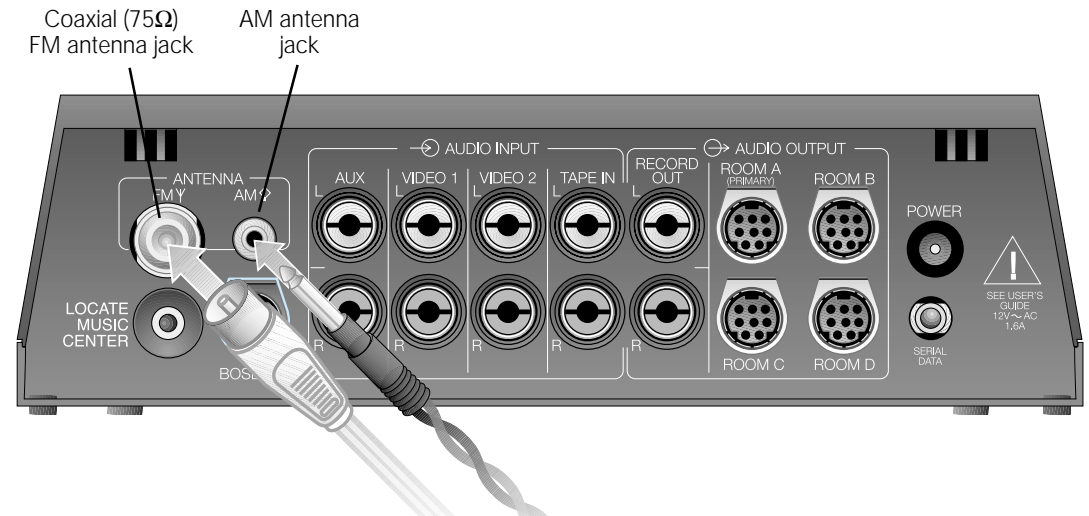

FM antenna connections

1. Plug the FM antenna connector into the FM ANTENNA jack on the back of the interface.
2. Spread out the antenna arms. Experiment with both the placement and the angle of this antenna to provide optimum FM reception.

♪ *Note:* A central antenna or cable, or an outdoor FM antenna, may be used with the multi-room interface antenna connections. To install an outdoor antenna, consult a qualified installer. Follow all safety instructions.

Figure 12

The FM dipole antenna and AM loop antenna

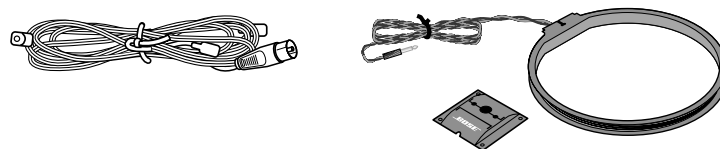

AM antenna connections

- ♪ *Note:* To install the AM antenna on a wall, follow the instructions enclosed with the antenna.
1. Plug the AM antenna microplug into the AM ANTENNA jack on the interface.
 2. Stand the loop antenna on the base, following the instructions enclosed with the antenna.
 3. Move the loop part of the antenna as far away from the multi-room interface as possible, but at least 20 inches (50 cm) away, and at least 4 feet (1.2 m) from the Acoustimass® module. Experiment with the orientation of the loop for optimum AM reception.

Connecting to a cable radio signal

To connect your system to the FM signal available from some cable TV companies, contact your cable provider for assistance. The connection is made to the FM 75Ω EXTERNAL antenna connector on the back of the interface.

⚠ **CAUTION:** Be certain that the installation includes a signal splitter so that only the FM band, not the cable TV band, is transmitted to the system. It is necessary to use a splitter that filters the signal to prevent any re-emissions of the TV spectrum through the system.

Completing connections and turning on the Acoustimass® module

Figure 13

Turning on the Acoustimass module

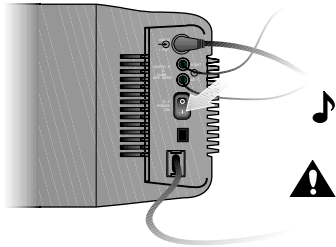

1. Plug the Acoustimass® module power cord into an AC power (mains) outlet.
2. Plug the multi-room interface power pack into an AC power (mains) outlet.
3. When you have checked all connections, be sure to turn the Acoustimass module power switch on (Figure 13). It is not necessary to turn the module off after each use. The system turns on and off automatically as it receives a signal from the Personal™ music center. Turn the system off using the Personal music center.

Note: Your speakers will not operate unless you complete all cable and power connections before turning on the system.

CAUTION: Be sure the three shipping screws on the bottom of the CD changer have been removed before turning on the system.

Setting up the Personal music center

Set up the Personal music center after the rest of the system is connected, plugged in, and the Acoustimass module has been turned on.

Note: When batteries are first installed in the Personal music center, it sets up a radio-frequency link with the closest multi-room interface.

1. Hold the Personal music center within a few feet of the multi-room interface.
2. Slide open the battery compartment on the back of the Personal music center (Figure 14).
3. Insert 4 AAA or IEC-R03 1.5V batteries, or the equivalent, as shown. Match the + and – symbols on the batteries with the + and – markings inside the compartment.
4. Slide the battery compartment cover back into place.
5. Turn the Personal music center over and touch the screen to wake it up if it appears blank. Press ON/OFF, FM, or any other source button to turn the system on.

If the Personal music center continuously displays “NO RESPONSE,” you need to try to establish its link with the multi-room interface again. Hold the Personal music center close to the multi-room interface. Press and hold MUTE for about 5 seconds until you hear a beep and then release. After about 10 seconds, the music center should beep twice to confirm that the link is established.

Figure 14

Installing batteries and waking up the display for the first time

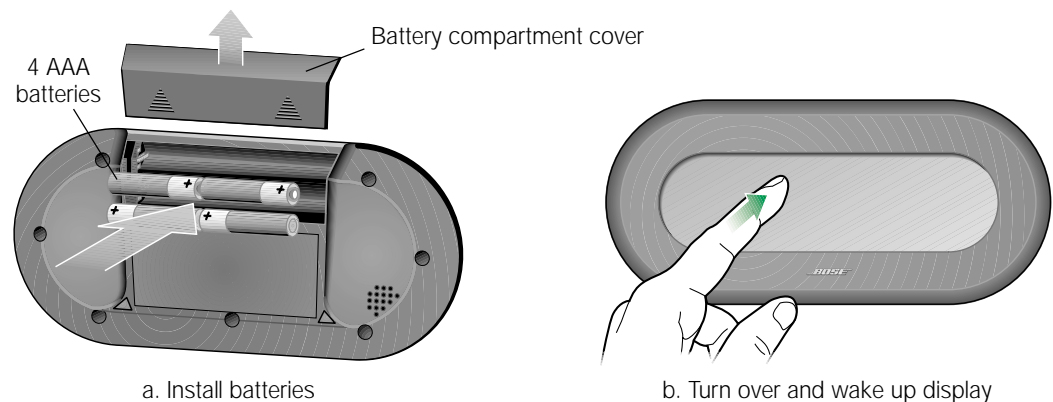

Note: Replace the batteries when the LOW BATTERY message first appears. See “Replacing batteries” on page 36. Alkaline batteries are recommended.

Turning on the system

You are ready to enjoy your new Lifestyle® system. Your Personal™ music center places complete control of the system operations in your hands. The center is portable, communicating with the rest of the system through a two-way radio-frequency link. The display is backlit for easy viewing, and provides visual feedback of current system operations and the available options. To allow for maximum battery life, the display and backlight turn off a short time after your last button press. You only need to touch the screen to wake up the music center.

- To learn more about the display, see “Using the Personal music center display” on pages 16-17.
- To operate the AM/FM radio, see “Listening to the radio” on pages 18-20.
- To operate the CD changer, see “Listening to compact discs” on pages 21-26.
- To control external components, see “Using the system with external components” on pages 26-27.
- To use your system in multiple rooms, see “Operating in more than one room” on pages 33-35.

Turning the system on

1. Touch the music center screen to wake up the display (Figure 15). The last display that you used appears on the screen.
2. Press ON/OFF to turn the system on to the last source used, or press a SOURCE button (FM, AM, CD, VIDEO 1, VIDEO 2, TAPE, AUX) to select and turn on that source (Figure 16).

Figure 15

Waking up the display

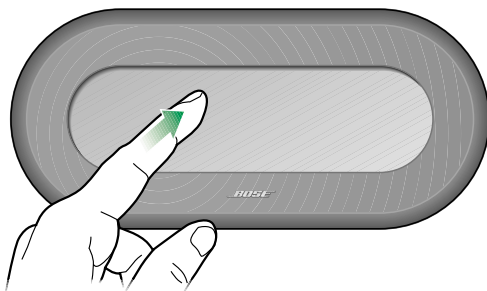
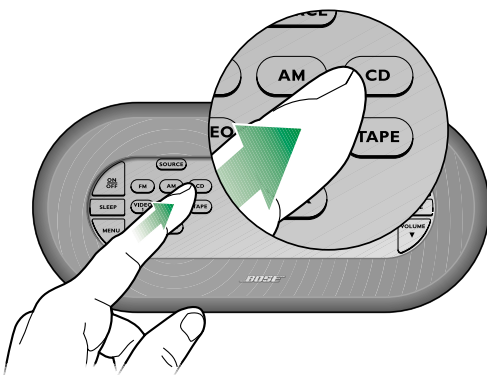

Figure 16

Turning on a source



Turning the system off

- Press the ON/OFF button.

Adjusting the volume

- Touch the VOLUME ▲ (up) or ▼ (down) button to raise or lower the volume.
- Volume settings range from 0 to 100. Volume settings are displayed while being adjusted.
- If the volume was above 80 when the system was turned off, it will turn on at 80 (to prevent surprising you with an extremely high volume).

Muting your system

- Press the MUTE button to silence the system. MUTE flashes on the display when the system is muted.
- Press MUTE again or VOLUME ▲ to restore volume to the muted speakers.

Using the sleep timer

1. Press the SLEEP button to access the sleep timer for automatic shutoff. The display flashes a sleep time of 30 minutes or the most recent sleep time setting (Figure 17). The SLEEP indicator is also flashing.
2. Use the arrow buttons to set the sleep timer to 1 to 99 minutes.
3. Press the START button to start the counter. The START button disappears and a CLEAR button appears at the bottom of the display.

Figure 17

The SLEEP display

Before pressing START ...

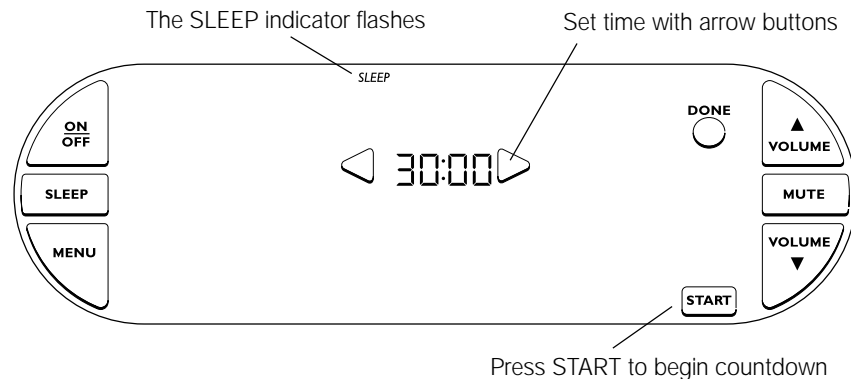

After pressing START ...

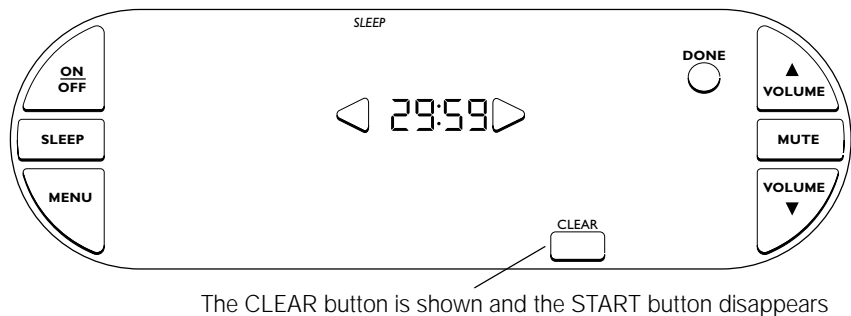

While the sleep timer is running, you can:

- Press CLEAR to cancel the timer.
- Press DONE to exit from the SLEEP display.
- Press SLEEP again to view the time remaining.

The selected SLEEP time is remembered by the music center. The next time SLEEP is selected, the display shows the last SLEEP time used.

Using the Personal™ music center display

The Personal music center display provides information on the system functions. The display offers different combinations of buttons to provide control of the function you are using. Sometimes an item on the display will flash to provide information about a system function. When an item flashes faster, it is alerting you to a needed action.

Using the primary buttons

The primary buttons (ON/OFF, SLEEP, MENU, VOLUME, and MUTE) are located at the left and right sides of the display.

Figure 18

The display showing the primary buttons, SOURCE buttons, and KEYPAD buttons

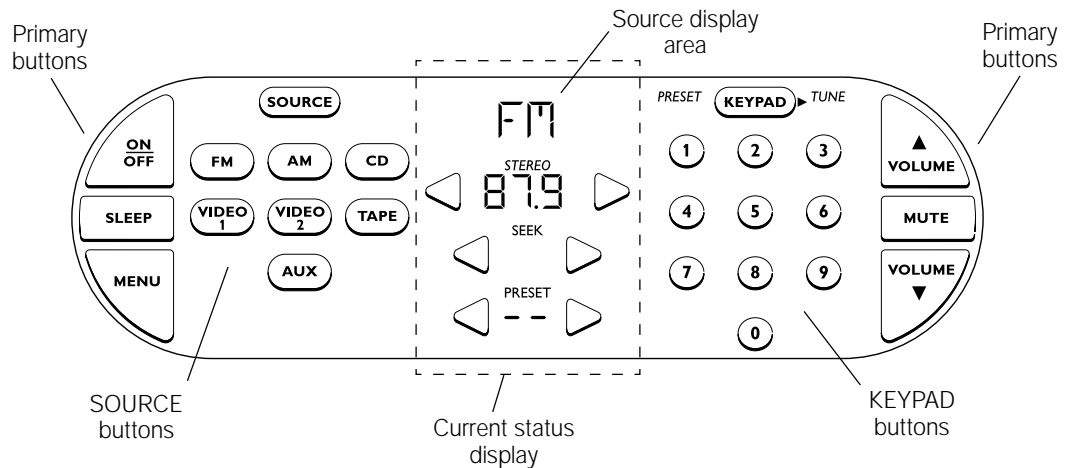

Using the SOURCE buttons

The seven source buttons provide direct access to the three built-in sources (FM, AM, CD) and up to four external components connected to the system. The Lifestyle® system can select an external component and adjust the volume, but it cannot turn a connected component on or off.

Use the SOURCE button to show or hide the source buttons.

Using the KEYPAD buttons

The numeric buttons provide direct access to commonly used features of the three built-in sources (FM, AM, CD). The ◀ or ▶ arrow symbol to the left or right of the KEYPAD button indicates whether you are using the keypad for presets or tuning (in FM or AM mode), or selecting disc or track (in CD mode).

Use the KEYPAD button to show or hide the keypad buttons and select PRESET or TUNE, or DISC or TRACK.

Using the current status display

The center of the touchscreen displays information about the current status of the system. The top of the status area indicates which source is selected or if the power is off. The next three lines let you set tuner or CD functions, using the ◀ or ▶ arrow buttons to adjust the settings. The center area also includes indication of CD modes such as RANDOM and REPEAT, or if the SLEEP function is on.

Using the MENU items

The menu items are selected by pressing the MENU button to step through the list until the function you want is displayed. Menu items are available in the list if they are applicable to the current state of the system. You can exit from any menu item by pressing DONE or ON/OFF or pressing MENU until you return to the main screen.

Figure 19

Selecting MENU items – one at a time

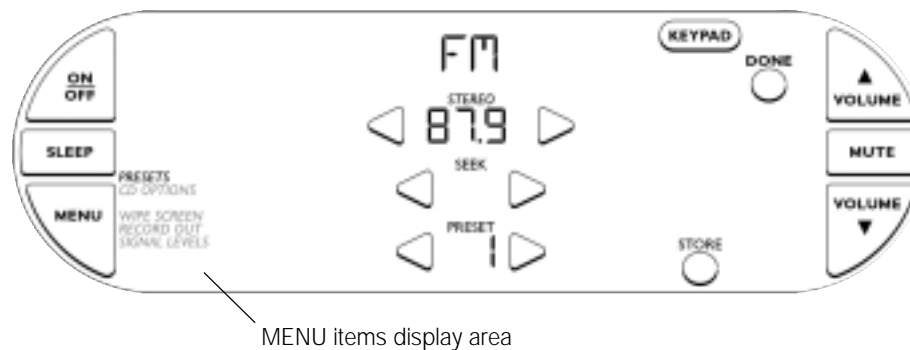

PRESETS

You can preset a maximum of 25 FM and 25 AM radio stations. In addition to using the PRESETS menu, you can set presets directly from the KEYPAD buttons. See pages 19-20.

WIPE SCREEN

Select this option when you need to wipe the display to clean off fingerprints, etc. WIPE SCREEN allows you 20 seconds to clean the display without affecting the system operations. See “Cleaning the Personal™ music center” on page 37.

CD OPTIONS

Select this option to create and edit a CD play list even if you are listening to another source. If you are in CD mode, you can also select random and repeat play. See “Using the CD OPTIONS menu” on pages 24-26.

♪ *Note: The next space in the MENU list is reserved for a feature of home theater systems.*

RECORD OUT

Use this option to select which source is directed to the RECORD OUT (line out) jacks, allowing you to listen to one source while recording another. See “Using a tape recorder with your system” on page 27.

SIGNAL LEVELS

The SIGNAL LEVELS option allows you to read the received signal strength of AM and FM radio stations. It also allows you to equalize the volume levels of externally connected components. See “Optimizing AM/FM radio reception” on page 28, or “Equalizing the volume levels of external sources” on page 29.

Listening to the radio

Your Lifestyle® music system has a built-in AM/FM radio. Good AM/FM radio reception depends on the location and orientation of the AM and FM antennas. See “FM antenna connections” and “AM antenna connections” on page 12 for proper antenna installation. See “Optimizing AM/FM radio reception” on page 28 for help with antenna adjustment.

Turning the system on and choosing the radio

Press FM or AM to turn your system on to the most recently selected FM or AM station. If the system is already on, use the FM or AM button to select either of these sources.

Setting radio channel spacing

On some multi-room interfaces, the AM and FM channel spacing can be set for North America (US: 10 kHz for AM and 200 kHz for FM) or Europe (EU: 9 kHz for AM and 50 kHz for FM). Select the channel spacing most appropriate for your area.

To change between US and EU channel spacing, press and hold the SOURCE button for two seconds. Press either arrow button until **tunr** appears. Using the arrow buttons, select US or EU. Press DONE to exit.

Selecting FM or AM

Press the FM or AM SOURCE button to turn on the radio band desired. Select a station by tuning manually, seeking a strong station, or selecting a preset station.

Manually tuning a radio station

To manually tune a radio station, press the ◀ (decrease) or ▶ (increase) arrow button on either side of the frequency display to change the frequency in small steps (Figure 20). Or, press the KEYPAD button until the indicator arrow ▶ points toward TUNE. Then use the number buttons to enter the frequency of the station you want to tune. The left-most digit is entered first and the display flashes while you enter more digits. When you have entered the station frequency, the system selects that station or the closest valid station.

Figure 20

Tuning the radio from the FM source display

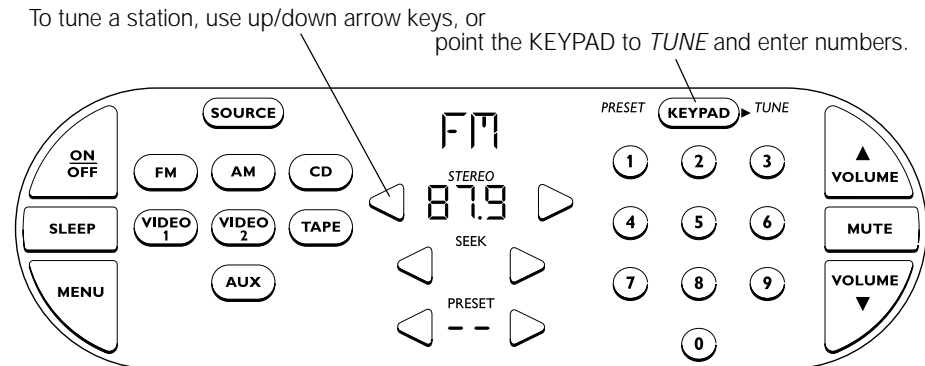

Receiving FM stereo or monaural broadcasts

When receiving sufficiently strong FM stereo broadcast signals, the radio automatically receives in the stereo mode; the *STEREO* indicator appears on the display. Weak stereo signals are received in the monaural mode (the *STEREO* indicator is off).

To force the tuner to receive in stereo mode only, press and hold the center of the station display until you hear a high-pitched beep. To receive in monaural mode only, press and hold until you hear a low-pitched beep. However, even though you may have forced the stereo mode, monaural broadcast material is still heard in monaural. Retuning the station cancels any forcing.

Receiving AM stations

Normally, the AM radio receives sufficiently strong AM stations using a wide bandwidth filter. If you experience difficulty tuning to a weak AM station, you can force the AM tuner to use a narrow bandwidth filter to eliminate interference from other stations.

To force the tuner to use a narrow bandwidth filter, press and hold the center of the station display until you hear a low-pitched beep. To switch back to the wide bandwidth filter, press and hold until you hear a high-pitched beep. Retuning the station cancels any forcing.

Seeking the strongest stations

Press either the ◀ or ▶ SEEK arrow button to tune to the next strong station.

Selecting a preset station

You can select a preset station using the ◀ or ▶ PRESET arrow buttons or the KEYPAD. To use the KEYPAD, press the KEYPAD button until the indicator arrow ◀ points toward PRESET. Then enter the number of the preset station you want.

♪ *Note: If you have not selected a valid preset location, the system remains at the current setting.*

Setting a station preset

Your Lifestyle® system can store up to 25 FM and 25 AM station presets. You can set presets using the STORE button, KEYPAD, preset number display area, or PRESET menu.

Setting a preset using the STORE button

During normal AM/FM radio operation when the keypad is not displayed, you can see the STORE button at the bottom of the screen. To store a preset in the next available location, press and hold the STORE button until the music center beeps and the new preset number appears.

♪ *Note: If all presets are full, the STORE button is not shown.*

Using the KEYPAD to quick-store presets

You can quick-store presets in locations 1 through 9. Hold down any KEYPAD number button from 1 to 9 until the music center beeps and the new preset number appears.

Setting a preset using the preset number display

You can quick-store a station using the PRESET number display. Press and hold down the display area between the PRESET arrow buttons (dashes or a preset number are displayed) until the system beeps. After the beep, the new preset number is shown. This stores a new preset at the next available preset number. Use the PRESETS menu (page 20) if you want to change a preset to a different station.

♪ *Note: If the display says FULL after pressing the PRESET number display area, no more presets are available. See "Erasing a preset station" on page 20.*

Figure 21

Setting presets using the preset number display or KEYPAD

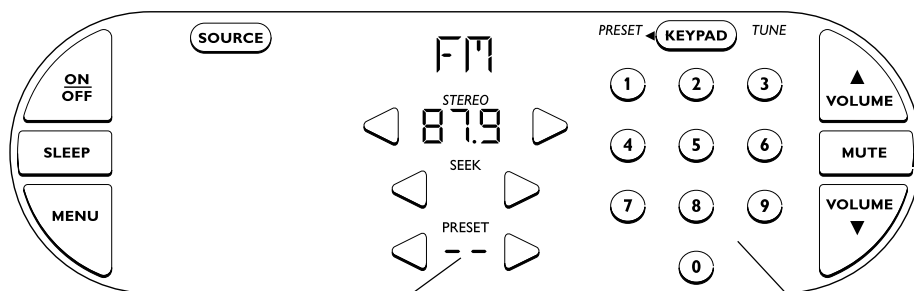

Press and hold here to store a preset or, to quick-store a preset, press and hold any button 1 through 9.

Setting presets using the PRESETS menu

You can set station presets using the PRESETS menu which is available only when AM or FM is the selected source.

To set a preset station:

1. Select the AM or FM source.
2. Press the MENU button once to access the PRESETS menu (Figure 22).
3. Select an unused preset number and then a station using the arrow buttons. Stations can also be selected using SEEK or the KEYPAD. Any preset number not used flashes on the display.
4. Press the STORE button to set the selected station to a selected preset number. To confirm a stored preset, the music center displays the station frequency and a CLEAR button (Figure 23). The CLEAR button appears whenever you select a stored preset, giving you the option of erasing the setting.

Figure 22

Selecting a station for a preset

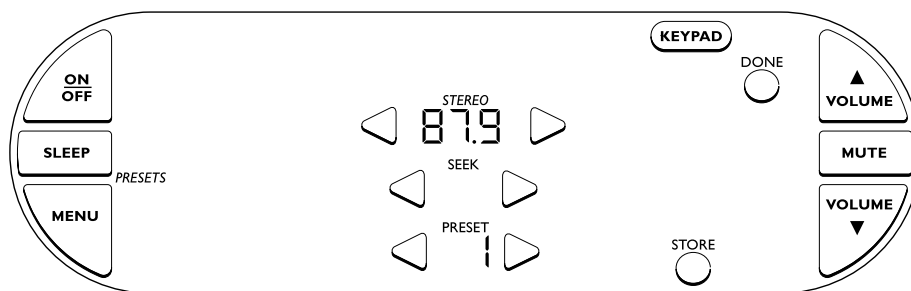

Figure 23

After setting a station as preset 3



Erasing a preset station

To erase a preset station, press MENU once to access the PRESETS menu. Select the preset number you want to erase and press CLEAR.

Managing your preset stations

Using the PRESETS MENU makes it easier to organize your preset stations, and store a specific station in a specific preset location. Here are some tips:

- Since any station can be assigned to more than one preset number, you can reserve a group of preset numbers for each household member to allow for different preferences.
- You can reserve different number groups for different types of stations.
- For easy reference, you may want to keep a written record of your presets.

Listening to compact discs

Using the CD changer

You can load the CD changer with up to six compact discs at a time.

Loading discs into the CD magazine

To load the CD magazine, hold it as shown in Figure 24. Insert up to six discs, label side up. Take care to place only one disc in each slot. Note the slot numbers 1 through 6, from bottom to top, on the front edge window. These numbers correspond to the CD numbers on the display.

! *CAUTION: Do not insert more than one disc into any slot. Forcing two discs into one slot could cause them to become stuck, and could damage the discs, the CD magazine, or the CD changer.*

♪ *Note: If a disc is upside-down, it does not play. The display flashes the disc number.*

Figure 24

Loading and ejecting a CD

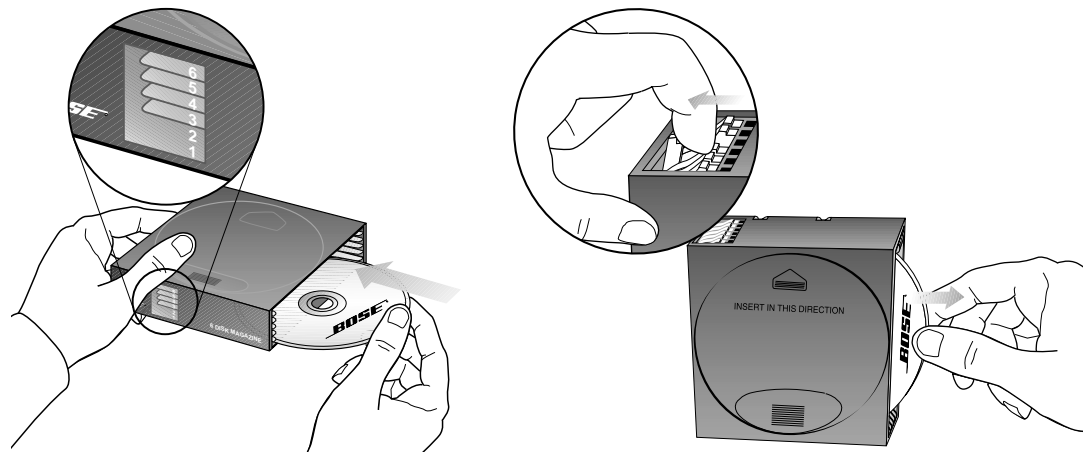

Ejecting discs from the CD magazine

Press the white lever that corresponds to the disc you want to eject. This ejects the disc far enough for you to grasp the edge and remove it from the magazine (Figure 24).

Loading the CD magazine into the CD changer

Open the CD changer door. Insert the CD magazine fully into the CD changer, following the direction of the arrow on the magazine (Figure 25).

Ejecting the CD magazine from the CD changer

Press the EJECT button, at the lower left of the magazine slot, to remove the magazine (Figure 25). If a CD is playing, pressing the EJECT button stops the CD, replaces it in the magazine, and ejects the magazine.

Figure 25

Loading and unloading the CD magazine

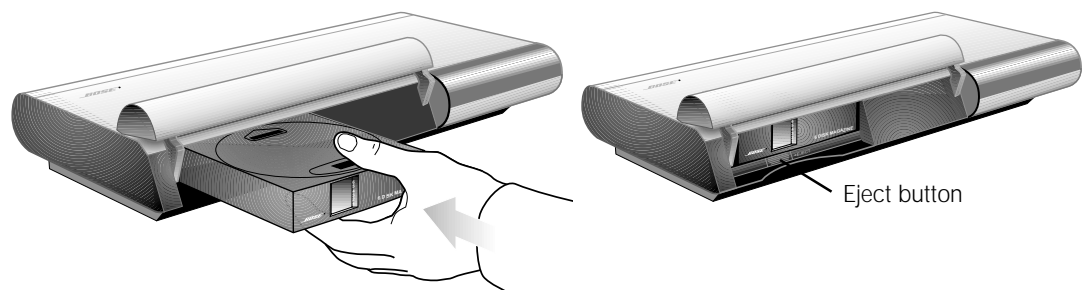

Turning the system on and choosing the CD changer

Press the CD source button to select the CD changer. If the system is off, this turns it on at the same time. When you press CD, the CD changer display (Figure 26) appears on the display. If a CD has been loaded, it begins to play. If no disc is installed, a **noCd** message is displayed.

 *Note: To prevent excessive wear on the CD mechanism, CD play or random play operations automatically stop after 24 hours.*

Figure 26
The CD changer display

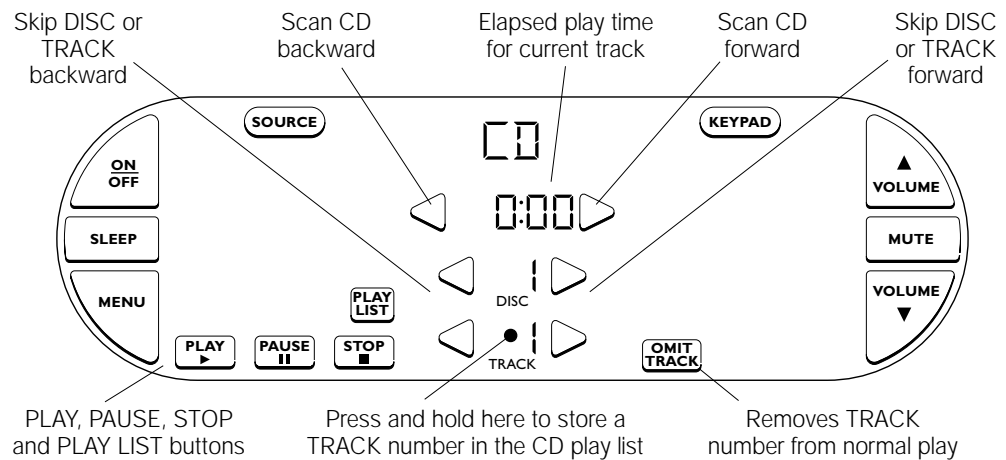

To play a CD

Press the PLAY ► button. The button symbol ► flashes until play begins.

To pause a CD

Press the PAUSE || button. The button symbol || flashes. Press PAUSE or PLAY to resume. If left unattended, the CD changer mode changes from PAUSE to STOP after 20 minutes. You can skip tracks forward or backward while paused.

To stop a CD

Press the STOP ■ or OFF button. If you press STOP ■, the disc number, total play time and number of tracks appear briefly on the display.

To skip to other tracks

To skip to the next track, press the TRACK forward ▷ button. To skip to the previous track, press the TRACK backward ◁ button. Pressing TRACK ◁ while playing a CD skips you to the beginning of the track in play.

To play another disc

Press the DISC forward ▷ or backward ◁ button. This skips you to the next or previous disc in the changer and starts playing the CD. The message *CHANGING* is displayed until play begins. Empty disc changer slots are automatically skipped.

To scan a disc

Press and hold the scan forward ▷ or backward ◁ button (these are the ones to the left and right of the play time display). Scanning back or forward stops at the first or last track of the disc. You can scan a CD while it is paused.

To add a track to the play list

Skip to the track you want to add to the play list. Press and hold the TRACK number display area. The current track number is stored in the next available location in the CD play list.

To omit a track from normal play

Select the TRACK number, then press and hold the OMIT TRACK button. You can omit up to 15 tracks and you can omit a track while it is playing. Omitted tracks are not played during normal, repeat, or random play modes.

You can skip to an omitted track using the TRACK forward ▷ or backward ◁ button. When on an omitted track, the word OMITTED is displayed and the OMIT TRACK button becomes CLEAR OMIT TRACK.

To clear an omitted track and restore it to normal play, skip to the omitted track number and then press CLEAR OMIT TRACK. To clear all omitted tracks at the same time, eject the CD magazine.

To listen to the CD play list

- Press the PLAY LIST button (Figure 27).
- To cancel PLAY LIST, press STOP, or press PLAY LIST again. If you press STOP, the current CD stops playing. If you press PLAY LIST again, the current CD continues to play.

♪ *Note: The PLAY LIST button appears only after you store CD selections in the play list memory. To program a play list, see "Programming a CD play list" on page 25.*

If the play list has an invalid entry, such as a track number that can't be found, it is skipped during play. If a CD was removed or exchanged, the system tries to play the disc as programmed. Unavailable items are skipped.

Figure 27

Display after pressing PLAY LIST

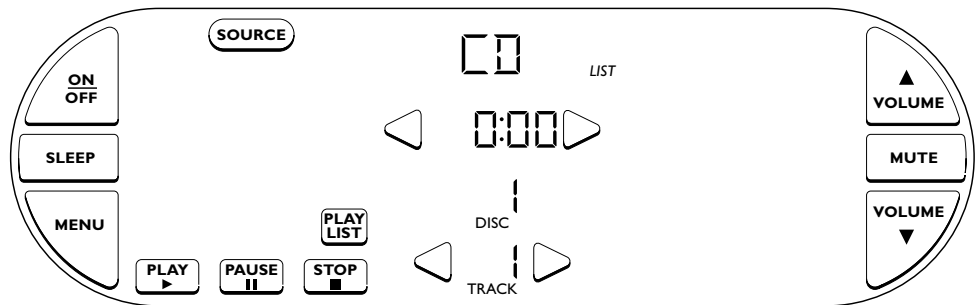

Using the CD OPTIONS menu

From the CD OPTIONS menu you can select repeat or random play, or program a CD play list. To access the CD OPTIONS, press the MENU button until CD OPTIONS is displayed (Figure 28). You can do this while a CD plays if you wish.

Figure 28

CD OPTIONS display

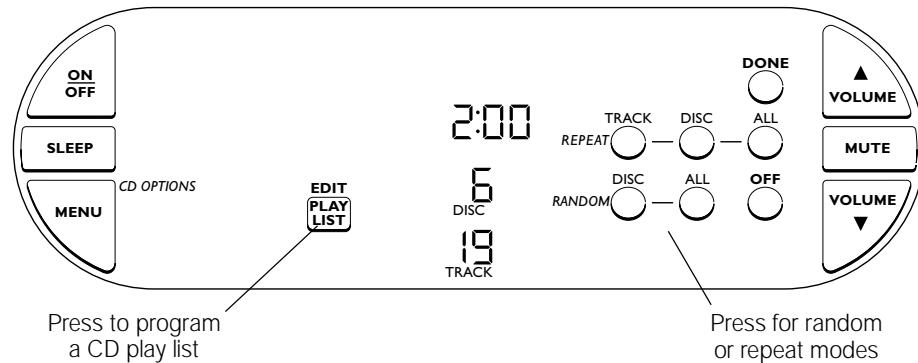

Selecting repeat and random modes

Repeat and random modes remain active until you press STOP ■ or OFF. To place the system in a repeat or random mode, go to the MENU button and select CD OPTIONS. Use the REPEAT and RANDOM buttons to select the mode you want. Press DONE to exit the CD OPTIONS menu. To cancel a repeat or random mode, press OFF in the CD OPTIONS menu. You can select the following repeat and random modes:

Mode	Press	What it does
Repeat track	REPEAT TRACK	Repeats selected track for 24 hrs.
Repeat CD	REPEAT DISC	Plays all tracks on selected disc in order. Repeats for 24 hrs.
Repeat all	REPEAT ALL	Plays all loaded discs in order. Repeats for 24 hrs.
Random CD	RANDOM DISC	Plays selected disc once in random order and stops.
Random all	RANDOM ALL	Plays all tracks on all discs once in random order and stops.
Repeat random CD	REPEAT DISC then RANDOM DISC	Plays selected disc in random order. Repeats for 24 hrs.
Repeat random all	REPEAT ALL then RANDOM ALL	Plays all discs and tracks in random order. Repeats for 24 hrs.

Selecting play list modes

You can also apply repeat or random modes to your CD play list. Press the PLAY LIST button before pressing the MENU button to select the CD OPTIONS menu. Then select one of the following play list modes using the REPEAT and RANDOM buttons. When you are through, press DONE to exit.

Play list mode	Press	What it does
Random list	RANDOM DISC or RANDOM ALL	Plays all selections in the PLAY LIST once in random order.
Repeat list	REPEAT DISC or REPEAT ALL	Repeats PLAY LIST.
Repeat track list	REPEAT TRACK	Repeats selected PLAY LIST item.
Repeat random list	REPEAT DISC or REPEAT ALL then RANDOM DISC or RANDOM ALL	Plays and repeats all selections in the PLAY LIST in random order.

♪ *Note: If you select random and repeat modes that cannot be combined (REPEAT TRACK and RANDOM DISC, for example), the system accepts the most recently entered choice.*

Programming a CD play list

Using the Lifestyle® system's programming feature, you can create your own CD play list of up to 50 tracks (including repeats) from the loaded discs. You can create or edit a CD play list even while listening to another source. However, you can't edit the play list while the list is playing. To create or edit a CD play list, press the MENU button and select CD OPTIONS.

♪ *Note: If you have more than one Personal™ music center, only one user can edit the play list at a time.*

To create a CD play list

1. Press EDIT PLAY LIST. The next available item number is flashing to indicate that the music center is ready for programming (Figure 29).
2. Select a DISC and TRACK number using the ◀ or ▶ arrow buttons.
3. Press STORE to enter the CD selection into memory under the selected ITEM number. The ITEM number stops flashing.
4. Press the ITEM right ▶ arrow for the next item number.
5. Repeat steps 2, 3 and 4 to add more items to the list. When the list has 50 programmed items, the STORE button disappears.
6. When you have completed your play list, press DONE to exit.

Figure 29

Starting to build the CD play list

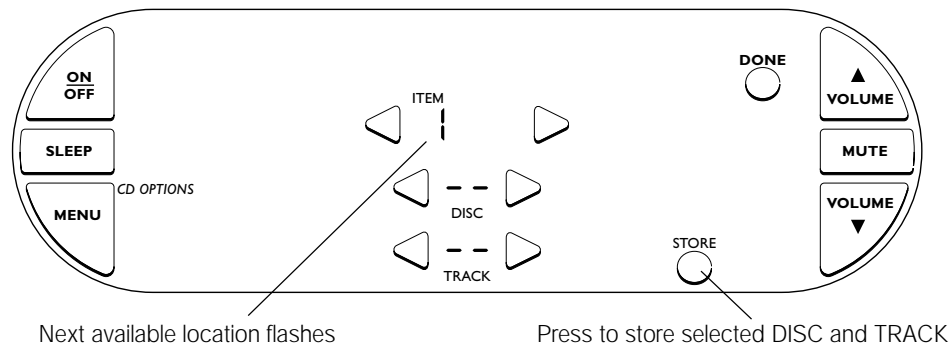

To change an entry in the CD play list

1. Press EDIT PLAY LIST. If the list has 50 items stored, the ITEM field indicates FULL and does not flash.
2. Select the number of the item you want to change and press CLEAR.
3. Select a new DISC and TRACK and press STORE.
4. To make other changes, repeat steps 2 and 3. Otherwise, press DONE to exit.

To insert a new track in an existing play list

1. Press EDIT PLAY LIST. If the ITEM field indicates FULL, you can't insert a new item unless you delete one or more items from the list.
2. Select the ITEM number of the location where you want to insert a new CD selection. The ITEM number should not be flashing.
3. Press INSERT (Figure 30). The ITEM number begins flashing to indicate that the item you were viewing was moved up one item number leaving your selected ITEM number available.
4. Select a DISC and TRACK number and press STORE.

To delete a track from the play list

1. Press EDIT PLAY LIST.
2. Select the number of the item you want to delete and press CLEAR (Figure 30). The TRACK and DISC numbers change to dashes. The location is cleared and all items after this one are moved down one item number.
3. To delete other items, repeat step 2. Otherwise, press DONE to exit.

Figure 30

CLEAR LIST and CLEAR buttons available on the display after first selection is entered

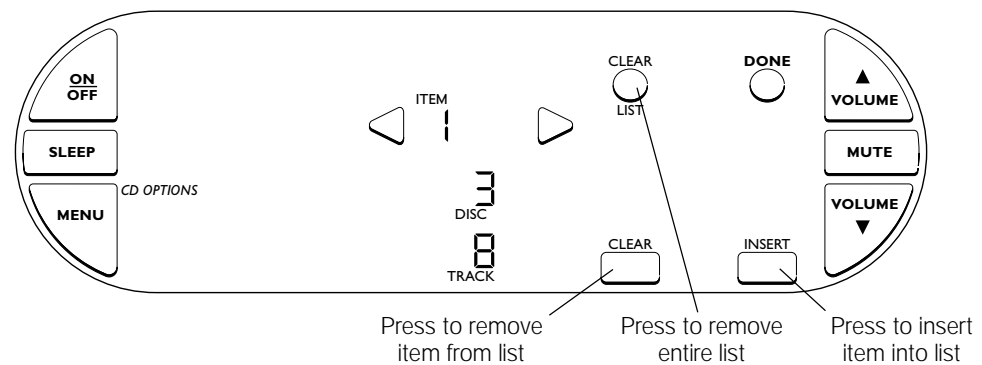

To erase the entire CD play list

1. From the CD OPTIONS menu, press CLEAR LIST.
2. Press YES to confirm.

Using the system with external components

Follow the instructions on page 11 for connecting components.

Turn on your component directly or by using its remote control. Press VOLUME ▲ or ▼ on your Personal™ music center to raise or lower the volume. Control all other functions at the source, referring to its owner's manual if necessary. To begin, make sure the component is turned on and a tape, CD, DVD, laserdisc, etc. is loaded. If an external component sounds significantly louder or softer than other sources, see "Equalizing the volume levels of external sources" on page 29.

♪ *Note: The Lifestyle® 40 music system cannot turn a connected component on or off.*

Turning the system on and selecting the component

Press VIDEO 1, VIDEO 2, AUX, or TAPE on your Personal music center to select the desired component. This turns your system on and selects the component connected to that input. If the system is already on, this button selects the component.

The appropriate display indicator appears when the system is on and the component is selected.

⚠ **CAUTION:** *The magnetic field from the Acoustimass® module is not an immediate risk to your video tapes, audio tapes, and other magnetic media. However, you should not store tapes directly on or near the Acoustimass module.*

Using a tape recorder with your system

If you are listening to any source except TAPE, the output signal of that source is directed to the RECORD OUT jacks.

♪ *Note: The ROOM outputs of the Lifestyle® 40 system are designated by the letters A through D. In a multi-room system, the source that is playing in the room designated by the letter closest to the beginning of the alphabet is sent to the RECORD OUT jacks.*

You may also specify a source to be directed to the RECORD OUT jacks even if you are not listening to that source. To do this:

1. Select RECORD OUT with the MENU button. The words RECORD OUT are displayed under the source display area (Figure 31).
2. Select a source to record. The selected source appears in the source display area in place of the dashes (Figure 31). If you want to remove your RECORD OUT selection, press CLEAR. The dashes reappear.

The selected source stays on until you turn RECORD OUT off. If the CD changer is selected for RECORD OUT, it shuts off after 24 hours if you have not turned it off sooner.

3. When you are ready, set the tape deck to record.

Figure 31

The RECORD OUT MENU display

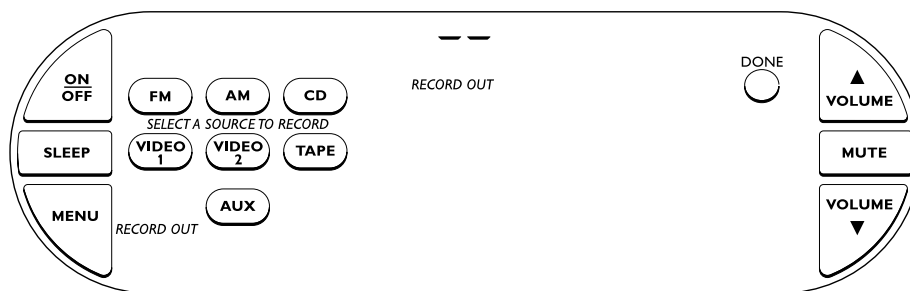

Fine-tuning your system

Figure 32

Treble and bass controls

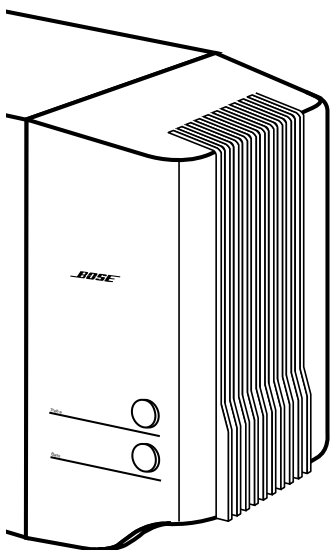

In most situations, you only need to follow the speaker placement guidelines (see “Setting Up” on pages 6-7) for your system to provide excellent sound quality. You do not need to adjust tone settings for changes in volume, since Bose® patented integrated signal processing provides a natural tonal balance over the full range of volume settings. If desired, you can further fine-tune your system as described here.

Adjusting speaker controls

The Lifestyle® 40 music system treble and bass controls are located on the Acoustimass® module (Figure 32). They allow you to adjust the treble (high frequencies) and bass (low frequencies). In the normal setting, the dots on each control are in the 12 o’clock position. You can also locate the normal setting by feeling when the control settles into the notch at this position. Turn the controls clockwise to increase, and counterclockwise to decrease, the amount of treble or bass.

Compensating for room acoustics

The acoustics (sound qualities) of your room can affect the overall sound quality of any speaker system. In general, you can reduce many problems with acoustics by the careful use of the treble and bass controls.

Too much or too little treble

Rooms that reflect a lot of sound, especially those with bare floors and walls, may sound overly shrill or “bright.” Turning down the treble control (toward –) decreases treble sound. Rooms with a lot of sound-absorbing furnishings, such as upholstered furniture, wall-to-wall carpet, or heavy drapes, may sound muffled or dull. Moving speakers further away from soft furnishings increases treble. You can increase treble sound by slightly turning up the treble control (toward +).

Too much or too little bass

You can decrease bass sound by turning down the bass control (toward –). To increase bass, turn up the bass control (toward +). Acoustimass module placement also affects the amount of bass you hear. Placing the module closer to the corner of the room increases bass. Moving the module away from the corner decreases bass.

Optimizing AM/FM radio reception

You can adjust the orientation of your AM/FM antenna for the strongest signal by selecting *SIGNAL LEVELS* with the MENU button (Figure 33). Select the AM or FM radio, and the display shows you the strength level of the received signal. While watching the display, reposition your antenna until the highest possible signal level is achieved. The signal level can vary from 0 to 99. The manual tuning keys are provided so that you can check the signal strengths of multiple stations.

Figure 33

AM/FM ANTENNA SIGNAL display

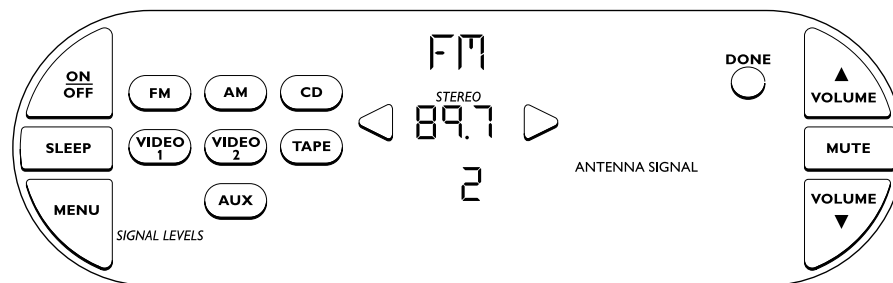

Equalizing the volume levels of external sources

The *SIGNAL LEVELS* selection in the MENU options allows you to adjust and equalize the volume gain levels received from externally connected sources (VIDEO 1, VIDEO 2, AUX, TAPE). For example, you can adjust the gain level of an external source so that volume level 50 on this source sounds as loud as level 50 from a built-in source.

1. Using the MENU button, select *SIGNAL LEVELS*.
2. Press VIDEO 1, VIDEO 2, TAPE or AUX and you are shown a gain adjustment display (Figure 34). After listening to the built-in sources (FM, AM, CD) at your preferred volume level, use the arrow keys to adjust the signal level settings (GAIN) of the connected sources until you get the same volumes. The adjustment range is from -15 to +15.

Figure 34

Gain adjustment display

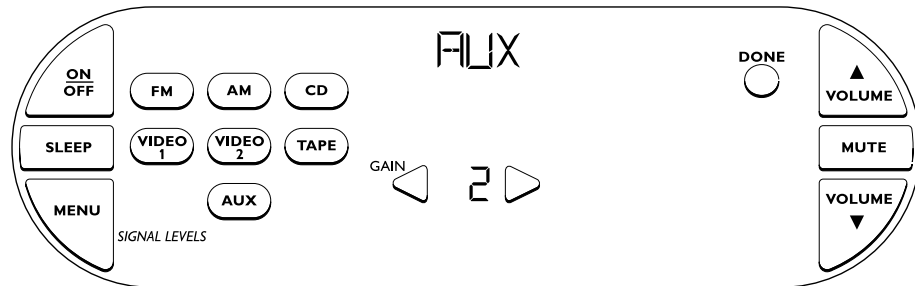

Adjusting LCD contrast

You can adjust the contrast of the display. Press and hold the SOURCE button until *Lcd* appears. Use the lower arrow buttons to change the contrast level.

Figure 35

LCD contrast adjustment display

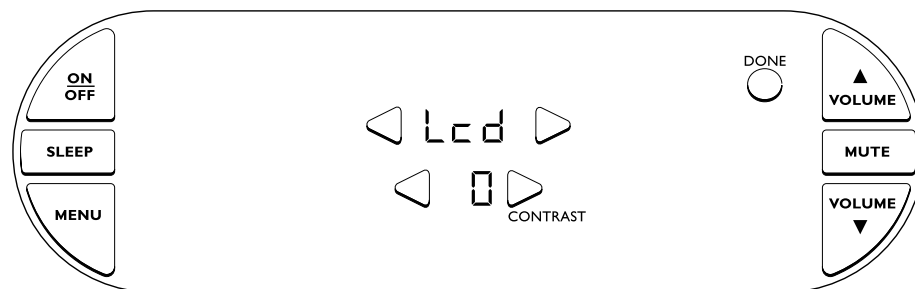

Adjusting the Personal™ music center beep

You can adjust the loudness of the beep made when pressing the display buttons. Press and hold the SOURCE button until *Lcd* appears. Use the upper arrow buttons to select the **bEEP** display. Use the arrow buttons to select between **Lo**, **HI**, and **--** (off).

Figure 36

Beep adjustment display

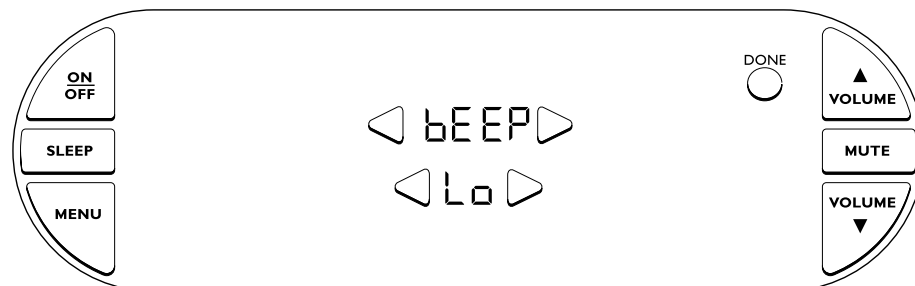

Forcing the SOURCE buttons to stay on

Normally, the SOURCE buttons are automatically removed from the display following certain operations. You can change the behavior of these buttons so that they remain in the state you last set them (on or off screen) using the SOURCE button.

1. Press and hold the SOURCE button until Lcd appears.
2. Press either upper arrow key until you see **STAY** and the SOURCE button appears in the upper left region of the display (Figure 37).
3. Press either lower arrow key to select Y (Yes).
4. To return the SOURCE buttons to normal operation, select N (No).

Figure 37

Selecting the display mode of the SOURCE buttons

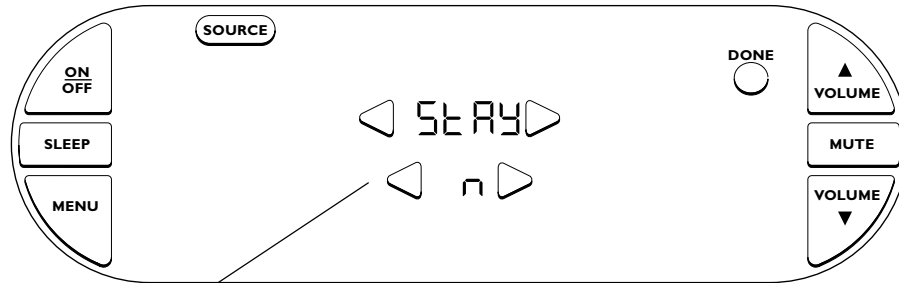

N = SOURCE buttons are removed following certain operations. Press SOURCE to access them again.

Y = SOURCE buttons remain as you last set them with the SOURCE button, except for when the system is off.

Forcing the KEYPAD buttons to stay on

Normally, the numerical keypad buttons are automatically removed from the display following certain operations. You can change the behavior of these buttons so that they remain in the state you last set them (on or off screen) using the KEYPAD button.

1. Press and hold the SOURCE button until Lcd appears.
2. Press either upper arrow key until you see **STAY** and the KEYPAD button appears in the upper right region of the display (Figure 38).
3. Press either lower arrow key to select Y (Yes).
4. To return the KEYPAD to normal operation, select N (No).

Figure 38

Selecting the display mode of the KEYPAD buttons

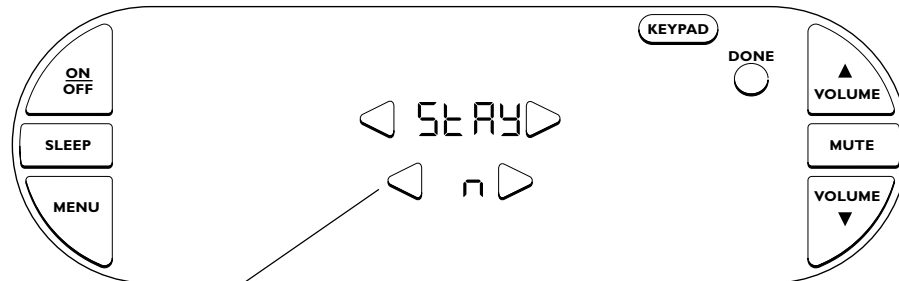

N = KEYPAD buttons are removed following certain operations. Press KEYPAD to access them again.

Y = KEYPAD buttons remain as you last set them with the KEYPAD button.

Adjusting the display fade time

The fade control display allows you to adjust the length of time the music center display stays on (after your last button press) before it fades. To adjust this time:

1. Press and hold the SOURCE button until Lcd appears.
2. Press either upper arrow key until you see **FAdE** on the display (Figure 39).
3. Press either lower arrow key to select a number between -15 and +15 (initial setting = 0). This is the number of seconds that is added or subtracted from the display fade time. A positive number keeps the display on longer than the initial setting. A negative number allows the display to fade sooner than the initial setting.
4. Press DONE to exit this mode.

Figure 39

Fade control display

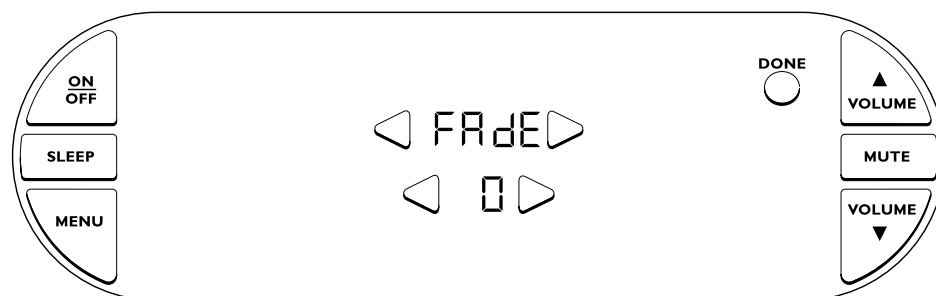

Connecting additional rooms

Follow the placement guidelines for the Bose® powered speakers that you plan to connect. Then review your plan for how to connect these speakers to the multi-room interface in your primary room. If you have questions or need extension cables to complete the connections, call Bose Customer Service at the numbers listed on the back inside cover of this owner's guide.



CAUTION: Make sure all components are unplugged from the power outlet before you begin hooking up additional speakers.

Connect the audio input cable from your additional powered speakers to the selected ROOM jack on the back of the multi-room interface.

1. Plug the small black multi-pin connector (flat side facing up) into the jack marked ROOM B, C, or D on the back of the interface.
2. Follow the instructions that came with your speakers for connecting the cable to the speakers.



Note: Be sure that each connector is inserted completely into each jack.

Figure 40

ROOM jacks on the multi-room interface

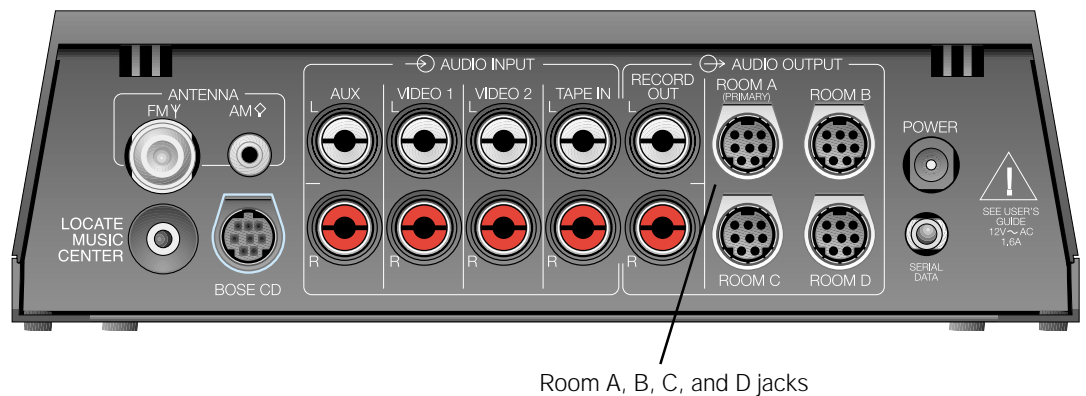

Note: If you connect Bose powered home theater speakers to your Lifestyle® 40 music system, it automatically offers controls for the SPEAKERS and FILM BASS options:

- Initially, the AM and FM sources turn on in 2-speaker mode (front right and front left). All other sources initially turn on in 5-speaker mode.
- Select SPEAKERS by pressing the MENU button. Use this option to select 5-, 3-, or 2-speaker mode and to adjust center and surround volume levels.
- FILM BASS is an enhanced listening mode designed for proper playback of movie soundtracks. When this mode is active, the words FILM BASS appear on the touchscreen. If you connect Bose powered home theater speakers to your Lifestyle® 40 music system, the FILM BASS feature is available for VIDEO 1, VIDEO 2, AUX, or TAPE. To turn FILM BASS on or off for these inputs, press the FILM BASS button.

Since the SPEAKER and FILM BASS options do not apply for stereo use, these controls do not appear when you use Bose powered stereo speakers.

Operating in more than one room

Your Lifestyle® 40 music system can control up to four sets of Bose® powered speakers, allowing your family to enjoy different audio sources (CD, radio, TV, etc.) in up to four rooms. These rooms are referred to as room A, B, C, and D, with room A being the primary room (the one used for a one-room system). If two or more rooms are connected to your system, the Personal music center displays ROOM and HOUSE buttons, and room indicators (A, B, C, and/or D). Figure 41 shows an example display for a two-room system.

Figure 41

Example display for a two-room system

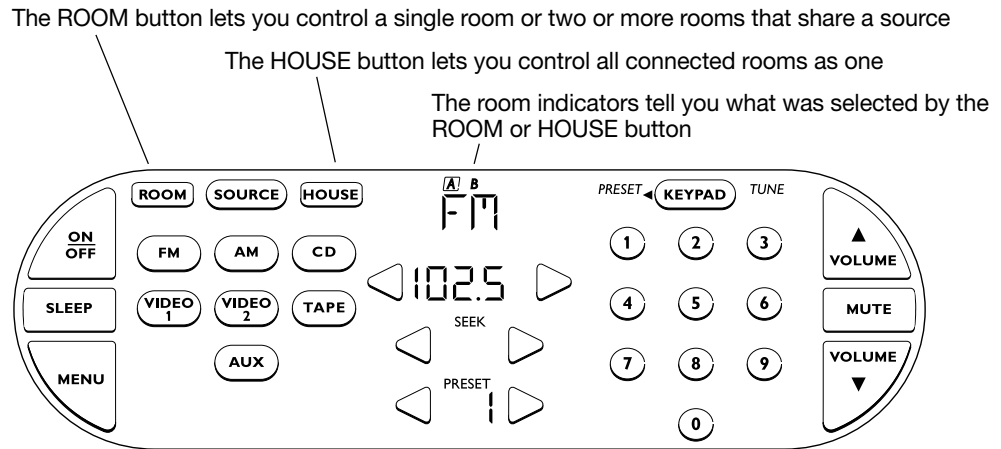

Understanding the room indicators

- A A boxed letter indicates the presently-selected room or rooms. The selected room is affected by any source changes, or any change you make using the VOLUME, MUTE, ON/OFF, or SLEEP buttons.
- B An unboxed letter indicates a room listening to a **shared source**. A shared source is one that is playing in the controlled room as well as in up to three additional rooms. If you change the radio station, CD track, etc., of the shared source, the change affects all rooms sharing this source. However, you cannot change sources for all affected rooms at the same time. The VOLUME, MUTE, ON/OFF, and SLEEP buttons only affect the boxed room(s).
- An empty box appears for each connected room when you press the HOUSE button. When you change the volume in the HOUSE mode, the numerical level appearing on the display does not represent the actual volume level in all connected rooms. It only represents the actual volume in rooms represented by a boxed letter.

Using the ROOM button

The ROOM button allows you to select any connected room and control any sound source you want to hear in that room. Each time you press the ROOM button you can transfer control from one room to the next in A-B-C-D order. The room indicators on the display tell you what is currently selected. Rooms listening to a shared source can be linked and controlled as one room.

Turning on different sources in more than one room

Let's say you have a two-room system (rooms A and B) and the entire system is off. To turn on a different source in each room:

1. Wake up the Personal™ music center.
2. Press the ROOM button until the room indicator **A** is displayed. Press a source button, such as VIDEO 1, to turn on the system and listen to your DVD player in room A. Adjust the volume to the desired level.
3. Press the ROOM button again. The room indicator **B** is displayed. Press a different source button, such as CD, to listen to a CD in room B. Again, adjust the volume to the desired level.
4. Press the ROOM button again and notice that the room indicator **A** is displayed. You are controlling room A once again and the display indicates that the VIDEO 1 source is on.

Setting up a shared source

Now, let's say the system is already on and you want to play the FM radio in rooms A and B:

1. Wake up the Personal music center.
2. Press the ROOM button until the room indicator **A** is displayed. Press the FM source button and adjust the volume to the desired level for room A.
3. Press the ROOM button again to select room **B**. Press the FM source button and adjust the volume to the desired level for room B. Now, the indicators **A B** are displayed.
4. Press the ROOM button again. The indicators **A B** appear on the display indicating that you can control these two rooms together. Any button command given now (SOURCE, VOLUME, MUTE, ON/OFF, SLEEP) is applied to both rooms.

 *Note: Remember that there are limits to using different sources in different rooms. With one tuner, the system cannot play one radio station in one room and another radio station in another. Similarly, with one CD changer, the system cannot play two different CDs at the same time.*

Controlling two or more rooms together

There are two ways to gain control of two or more rooms:

- Set up a shared source in two or more rooms and select them together using the ROOM button. See "Setting up a shared source" above.
- Control all connected rooms together using the HOUSE button. See "Using the HOUSE button" on page 35.

Returning to single-room control

After you have gained control of multiple rooms using the ROOM button, you can use the ROOM button again to gain control of a single room. Press ROOM until the room you want is displayed (**A**, **B**, **C**, or **D**). Control that room as desired.

Using the HOUSE button

The HOUSE button lets you control all connected rooms as if they were one. When you press the HOUSE button, an empty box indicator is displayed for each connected room. Any button pressed after that (any source button, VOLUME, MUTE, or SLEEP) affects every room. When you are done listening you can press OFF to turn off the entire system.

♪ *Note: If you do not press any additional buttons after pressing HOUSE, pressing HOUSE again cancels HOUSE mode.*

Press the HOUSE button before each command to apply that command to all rooms:

Press ...	To do this ...
HOUSE then a source	Play the selected source in all connected rooms.
HOUSE then VOLUME ▲▼	Adjust the volume up or down by the same amount in all rooms that are on, or all connected rooms if they are all off. The system remembers the differences among the original room volume settings.
HOUSE then MUTE	Silence all connected rooms that are on, even if any were previously muted individually. To cancel this command, press HOUSE then MUTE again. Any rooms that were muted before this command was given stay silent until individually unmuted. If you unmute an individual room after it was muted by a HOUSE - MUTE command, the other rooms remain silent until each one is unmuted individually. Pressing HOUSE then VOLUME ▲ unmutes all muted rooms.
HOUSE then SLEEP	Set the SLEEP timer for all rooms that are on. The SLEEP time selected applies to all rooms that are on even if they are playing different sources. If the SLEEP timer was already set in one or more rooms, the display shows the longest time already set. You can accept this time or change it for all the rooms. To cancel the HOUSE - SLEEP command, press HOUSE, SLEEP, CLEAR, and then DONE.
HOUSE then OFF	Turn off the entire system.

♪ *Note: Instead of setting one sleep time for the entire house, you can set different sleep times for individual rooms by using the ROOM button to select each room and setting SLEEP.*

When two or more rooms are controlled as one, adjusting the SLEEP time affects all rooms (indicated by boxed letters).

Using more than one Personal™ music center

If you have a multi-room system, you can add additional music centers in some or all of the connected rooms. Each multi-room interface can be controlled by a maximum of four music centers. Each music center can control up to four rooms.

To add a new music center to your system, follow the setup instructions on page 13. Be sure to install the batteries and turn it on for the first time close to the multi-room interface to allow the new music center to set up a radio frequency link with your system. If the multi-room interface is not plugged in or the music center is out of range, the display indicates NO RESPONSE.

Finding a misplaced Personal™ music center

The “find me” feature assists you in locating the Personal music center. Press the LOCATE MUSIC CENTER button on the back of the multi-room interface (under the antenna connections, next to the CD changer cable connection). The volume drops in any rooms that are on and any music center within range of the multi-room interface eventually begins beeping and flashing. The beeping and flashing continues for two minutes. Touching the screen of any music center cancels the LOCATE MUSIC CENTER function.

Figure 42

The LOCATE MUSIC CENTER button

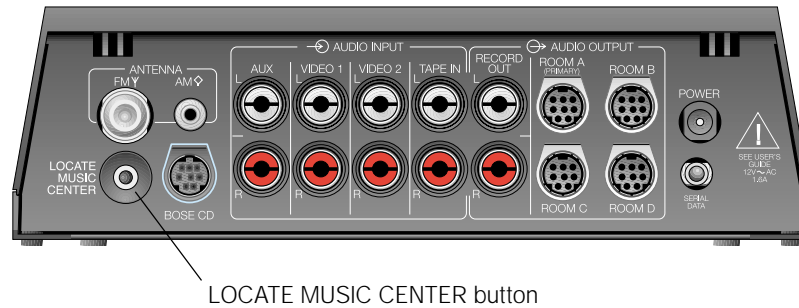

Replacing batteries

The *LOW BATTERY* message appears when batteries are nearly depleted. As batteries get weaker, the message flashes faster and display timeouts become shorter.

Figure 43

The *LOW BATTERY* warning message



System settings are not lost when batteries are changed or battery power fails.

Replace the batteries with 4 AAA or IEC-R03 1.5V alkaline batteries, matching the + and – symbols on the batteries with the + and – markings inside the compartment and on the back label. See “Setting up the Personal music center” on page 13 for battery installation instructions.

Cleaning the system

The only maintenance your system may need is periodic cleaning and replacing the Personal music center batteries. For information on replacing the batteries see page 13.



CAUTION: Do not use any spray cleaners near the system. Do not use any solvents, chemicals, or cleaning solutions containing alcohol, ammonia, or abrasives.



CAUTION: Do not allow liquids to spill into any openings of the system. If liquids accidentally get into any system component, turn the system off and allow it to air dry. Then turn it on again. If you notice any problems with its functioning, turn it off and contact Bose® Customer Service.

Cleaning the Personal™ music center

You can use an ammonia-free window cleaner on a soft cloth to clean the music center, including the display screen. See the cautions at the top of the page.

Before you start cleaning the display, press the MENU button until you select *WIPE SCREEN*. You can use this option to disable the display buttons for up to 20 seconds while you wipe the screen. When you are ready to wipe the screen, press START to begin the countdown. This enables you to clean the touchscreen without affecting system operation. The system beeps during the last five seconds to warn you that time is running out.

Figure 44

Entering the *WIPE SCREEN* display

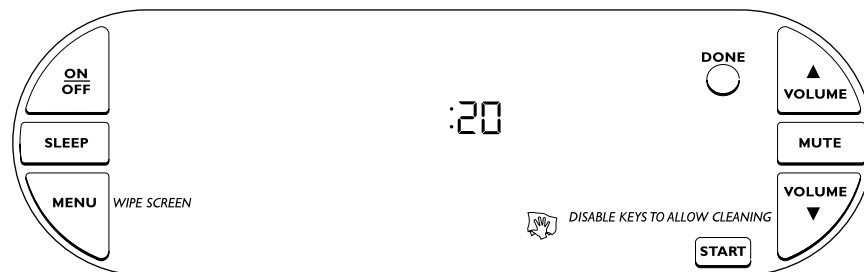

Cleaning the CD changer

Use only a soft cloth to clean the outside of the CD changer. See the cautions at the top of the page.

Cleaning the speakers and Acoustimass® module

Clean the surface of your speakers with a soft, damp cloth. You can use an ammonia-free window cleaner on a soft cloth to maintain the finish. See the cautions at the top of the page.

The speaker grille panels require no special care, although you may vacuum them carefully with a soft-bristled attachment, if necessary.

Troubleshooting

Problem	What to do
System does not function at all	<ul style="list-style-type: none"> • Make sure the power connector is inserted securely into the multi-room interface, the power cord is inserted securely into the Acoustimass® module, and the power pack and power cord are plugged fully into operating AC wall outlets. • Be sure to select a source (CD, AM/FM, etc.). • Unplug the multi-room interface power pack for a few seconds, then reconnect it. This allows the unit to reset itself after a power surge or power interruption.
No sound	<ul style="list-style-type: none"> • Increase the volume. • Check to see if MUTE is flashing on the display. If it is, press the MUTE button to unmute the sound. • Make sure the audio input cable is firmly seated in the multi-room interface ROOM A jack and the multi-pin connector on the other end is firmly seated in the Acoustimass module AUDIO INPUT jack. • Check speaker connections. • Check the connections for any external components. Make sure to select the correct source for the desired input. • Be sure the CD is placed correctly label-side up in the magazine, and the magazine is inserted properly in the CD changer. • Connect the FM and AM antennas.
Personal™ music center control is inconsistent, shows a <i>NO RESPONSE</i> message, or does not work	<ul style="list-style-type: none"> • Check batteries and their polarity (+ and –). See page 13. • Operate the music center closer to the multi-room interface. • Move the music center a few feet to avoid an area of interference. • Make sure the audio input cable is firmly seated, and uncoiled. • Make sure the multi-room interface is connected and plugged in. • If <i>NO RESPONSE</i> is continuously displayed, the link between your music center and the multi-room interface may be broken. To re-establish the link, hold the music center close to the interface. Press and hold MUTE for about 5 seconds until you hear a second beep. After about 10 seconds, you should hear two beeps to confirm that the link is established. <p> NOTE: <i>The music center establishes a link with the closest multi-room interface.</i></p>
CD does not play	<ul style="list-style-type: none"> • Check to see if the PLAY button symbol ► in the display is flashing. • Make sure the magazine is properly inserted. • Check to see if there is a disc in the magazine, label-side up. Display shows a flashing number for a disc that is label-side down or cannot be read. Display shows noCd if no discs are loaded. • Eject the magazine and try loading the CD again. • Check for dirt or dust on the CD. Clean the CD if necessary. • The disc may be defective. Try another disc. • Make sure the disc is not a DVD. The CD changer cannot play a DVD disc. • If the display shows Plug in cd, check that the CD changer is properly connected. • If the display message Err appears, there is a mechanical error. Call Bose® Customer Service (see inside back cover for listings).

<i>Problem</i>	<i>What to do</i>
Radio does not work	<ul style="list-style-type: none"> • Make sure antennas are connected properly. • Position the AM antenna as far away from the multi-room interface as possible, at least 20 inches away. • Adjust antenna position to improve reception. Use SIGNAL LEVELS MENU to determine best reception. You may be in an area of weak signal coverage. • AM antenna must be upright. • Move antennas farther from TV or other electronic equipment.
FM sound is distorted	<ul style="list-style-type: none"> • Adjust antenna position to reduce interference.
Sound is distorted	<ul style="list-style-type: none"> • Make sure speaker cables are not damaged and the connections are secure. • Reduce the output level from any external components connected to the CD changer.
No tape, CD, VCR, or TV sound	<ul style="list-style-type: none"> • Check the connections. • Make sure the component is turned on. • Refer to the component owner's manual.
A display button does not activate its function when pressed on center	<ul style="list-style-type: none"> • Calibrate the display screen. When you can only initiate a function by pressing the button too far off center, then a display screen calibration may be necessary. Calibrating the display screen aligns the button icon with the appropriate area of the screen. <ol style="list-style-type: none"> 1. Press and hold the source display area (top center) until CAL appears. 2. Press the SOURCE button as close to its center as possible. The KEYPAD button appears. 3. Press the KEYPAD button as close to its center as possible. A small round button appears at the bottom right of the screen. 4. Press the small round button as close to its center as possible to exit the calibration function with a newly calibrated screen. • Contact Customer Service for assistance.

Warranty period

The Bose® Lifestyle® 40 music system is covered by a limited 1-year transferable warranty. Details of the warranty are provided on the warranty card that came with your system. Please fill out the information section on the card and mail it to Bose.

Customer Service

For additional help in solving problems, contact Bose Customer Service. See the inside back cover for Bose Customer Service offices and phone numbers.

Technical information

Speaker system power rating

USA/Canada: 120V~ 50/60 Hz 350W

Europe/Australia: 220-240V~ 50/60 Hz 350W

Dual voltage: 115/230V~ 50/60 Hz 350W

Multi-room interface power pack power rating

USA/Canada: 120V~ 60 Hz 25VA

Europe: 230V~ 50 Hz 25VA

Australia: 240V~ 50 Hz 25VA

Dual voltage: 120V~ 60 Hz 25VA and
230V~ 50 Hz 25VA

Multi-room interface inputs

TAPE IN: 2Vrms, maximum

AUX, VIDEO 1, VIDEO 2: 2Vrms, maximum

FM antenna: 75Ω

AM antenna: 12μH

Power: 12V~, 1.0A

Multi-room interface outputs

RECORD OUT: fixed audio

ROOM A, B, C, D: auto-adjusting fixed or
variable audio

SERIAL DATA: for future use

ROOM connector pinouts:

- 1: left audio
- 2: right audio
- 3: left audio
- 4: right audio
- 5: audio ground
- 6: +10V control line
- 7: SMART SPEAKER data
- 8: control line ground

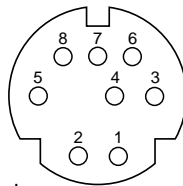

Personal™ music center

Power: 6V DC (1.5V x 4 AAA)

Range: 65 feet (20 m)

Dimensions

Personal music center

8.8" W x 4.1" D x 1.4" H
(22.4 cm x 10.5 cm x 3.6 cm)

Multi-room interface

7.4" W x 4.0" D x 2.1" H
(18.8 cm x 10.0 cm x 5.5 cm)

CD changer

15.5" W x 8.0" D x 2.6" H
(39.4 cm x 20.3 cm x 6.6 cm)

Jewel Cube® speaker

2.2" W x 3.2" D x 4.4" H
(5.6 cm x 8.1 cm x 11.2 cm)

Acoustimass® module

23.3" W x 7.5" D x 14.0" H
(59.0 cm x 19.0 cm x 35.5 cm)

Weights

Personal music center

.8 lb (.4 kg)

Multi-room interface

.8 lb (.4 kg)

CD changer

5.9 lb (2.7 kg)

Jewel Cube speaker

1 lb (0.5 kg)

Acoustimass module

33 lb (15.0 kg)

Total shipping weight

54 lb (24.5 kg)

Finish

Personal music center

Polymer, painted

Multi-room interface

Polymer

CD changer

Aluminum

Jewel Cube speakers

Polymer, painted

Acoustimass module

Vinyl veneer, Polymer

Accessories

To find out about mounting brackets, stands, CD magazines, and connecting additional Bose® powered loudspeakers, contact your Bose dealer. Or call Bose directly (see inside back cover for phone numbers).

- A**
- Acoustimass® module
 - best bass performance 7
 - connections 8, 9, 13
 - location 7
 - magnetic field 7, 27
 - on and off 13
 - power cord 13
 - power switch 13
 - rubber feet 7
 - TREBLE and BASS controls 28
 - turning on 13
 - ventilation 7
 - Additional powered speakers 32
 - Additional rooms
 - connecting 32
 - operating 33
 - AM 14, 16, 18
 - AM/FM radio
 - antenna 5
 - antenna connections 12
 - antenna placement 12
 - channel spacing 18
 - reception 28
 - select 14
 - station preset 19
 - TUNE 18
 - ANTENNA SIGNAL 28
 - AUDIO INPUT
 - external components 11
 - jacks 11
 - AUDIO OUTPUT
 - additional rooms 32
 - connections 32
 - PRIMARY 9
 - AUX 14, 32
- B**
- Bass control 28
 - Batteries
 - first installed 13
 - replacing 36
 - Beep adjustment display 29
 - Built-in sources 16
- C**
- CAUTION marks 2
 - CD 14, 16
 - built-in source 16
 - CD OPTIONS 17
 - changer 21
 - CD changer
 - display 22
 - loading 21
 - location 7
 - omit a track 23
 - PAUSE 22
 - PLAY 22
 - select 22
 - shipping screws 5, 13
 - STOP 22
 - TRACK 22
 - CD magazine
 - ejecting 21
 - ejecting discs 21
 - loading 21
 - CD modes
 - play list 24
 - repeat and random 24
 - CD OPTIONS 17, 24
 - display 24
 - menu 24
 - PLAY LIST 25
 - programming 25
 - repeat or random play 24
 - CD play list
 - CLEAR, CLEAR LIST 26
 - EDIT 26
 - erase 26
 - FULL 26
 - INSERT 26
 - ITEM 25
 - programming 25
 - STORE 25
 - Cleaning 37
 - Acoustimass module 37
 - CD changer 37
 - personal music center 37
 - speakers 37
 - WIPE SCREEN 17, 37
 - CLEAR, CLEAR LIST 26
 - CLEAR OMIT TRACK 23
 - Connecting powered speakers 32
 - Customer Service 39
- D**
- DISC
 - scan 23
 - skip 22
 - display contrast 29
 - DONE
 - CD OPTIONS 24
 - EDIT PLAY LIST 26
 - MENU 17
 - SLEEP 15
 - WIPE SCREEN 37
- E**
- EDIT PLAY LIST 26
 - Ejecting
 - CD magazine 21
 - discs 21
 - Err 38
 - External components
 - connect 11
 - selecting 27
 - using 27
 - volume gain levels 29
 - External tape deck
 - inputs/outputs 11
 - recording 27
- F**
- FILM BASS 32
 - FM 14, 16, 18
 - FULL 26
- G**
- GAIN
 - adjustment 29
 - of external sources 17
 - volume levels 29
- H**
- HOUSE
 - button 33, 35
 - indicators 33
- I**
- INSERT 26
 - ITEM 25
- J**
- Jewel Cube® speakers
 - cleaning 37
 - connecting 8
 - locations 6
- K**
- KEYPAD buttons
 - presets or tuning 16
 - show or hide 16, 30
- L**
- LCD contrast 29
 - Loading the CD magazine 21
 - LOCATE MUSIC CENTER 36
 - Locations
 - Acoustimass module 6, 7
 - Jewel Cube speakers 6
 - LOW BATTERY 13, 36

- M**
- Magnetic field 7, 27
 - MENU**
 - CD OPTIONS* 24
 - exit* 17
 - PRESETS* 20
 - primary button* 16
 - RECORD OUT* 27
 - SIGNAL LEVELS* 28, 29
 - Multi-room interface
 - antenna connections* 12
 - inputs* 40
 - location* 7
 - outputs* 40
 - power pack* 13
 - rear panel* 12
 - MUTE** 16, 35
- N**
- NO RESPONSE** 13, 35, 38
 - noCd 22, 38
- O**
- OMIT TRACK** 23
 - ON/OFF** 13, 14, 16
- P**
- Personal™ music center
 - batteries* 13
 - battery compartment* 13
 - beep* 29
 - display* 16
 - finding a misplaced* 36
 - MENU items* 17
 - primary buttons* 16
 - radio-frequency link* 13
 - range* 40
 - set up* 13
 - SOURCE buttons* 16
 - using more than one* 35
 - waking up* 14
 - PLAY LIST** 25
 - change an entry* 25
 - CLEAR LIST* 26
 - create* 25
 - delete a track* 26
 - erase* 26
 - insert a new track* 26
 - ITEM* 25
 - Plug in cd 38
 - Power rating
 - power pack* 40
 - speaker system* 40
- PRESETS** 17
 - menu* 19, 20
 - number display* 19
 - selecting* 19
 - setting* 19
 primary buttons 16
- R**
- Radio channel spacing 18
 - Radio-frequency link 13
 - RANDOM** 24
 - RECORD OUT**
 - display* 27
 - jacks* 27
 - option* 17
 - source* 27
 - REPEAT** 24
 - ROOM**
 - button* 33
 - jack pinouts* 40
 - jacks* 9, 32
- S**
- Safety Information 2
 - SEEK** 19
 - Serial numbers 3
 - Shared source 33
 - SIGNAL LEVELS** 17, 29
 - Signal splitter 12
 - SLEEP** 15, 16, 35
 - SOURCE buttons** 16, 30
 - SPEAKERS** 32
 - Speakers
 - additional* 32
 - cleaning* 37
 - connecting* 8
 - placement* 6
 - powered* 32
 - START**
 - SLEEP* 15
 - WIPE SCREEN* 37
 - Station presets
 - erasing* 20
 - managing* 20
 - maximum* 17
 - preset number* 19
 - PRESETS menu* 17
 - quick-store* 19
 - selecting* 19
 - setting* 19, 20
 - STORE**
 - CD play list* 25
 - preset* 19, 20
- System**
- accessories* 40
 - additional cables* 7
 - connecting* 8–10, 12, 13
 - control* 14
 - current status display* 16
 - dimensions* 40
 - fine-tuning* 28
 - finish* 40
 - muting* 15, 16, 35
 - ON/OFF* 14
 - parts* 5
 - serial numbers* 3, 5
 - troubleshooting* 38–39
 - turning on* 14
 - unpacking* 5
 - VOLUME* 15
 - weight* 40
- System cables**
- audio input* 5, 9
 - CD changer* 5, 9
 - extension wire* 8
 - speaker cables* 5
 - to lengthen* 8
- T**
- TAPE** 14, 27, 32
 - Technical information 40
 - Treble control 28
 - Troubleshooting 38–39
 - TUNE** 18
 - Tuning
 - manually* 18
 - selecting a preset* 19
 - strongest stations* 19
 - tunr 18
- U**
- Unpacking 5
- V**
- VIDEO 1** 14, 32
 - VIDEO 2** 14, 32
 - VOLUME**
 - adjusting* 15
 - equalizing* 29
 - HOUSE* 35
 - primary buttons* 16
- W**
- WIPE SCREEN** 17, 37



USA

Bose Corporation, The Mountain
Framingham, MA 01701-9168
1-800-367-4008
Phone hours - ET (eastern time):
Weekdays 9 a.m. to 8 p.m.
Saturdays 9 a.m. to 3 p.m.

Canada

Bose Ltd., 1-35 East Beaver Creek Road
Richmond Hill, Ontario L4B 1B3
1-800-465-2673
Phone hours - ET (eastern time):
Weekdays 9 a.m. to 5 p.m.

European Office

Bose Products B.V., Nijverheidstraat 8
1135 GE Edam, Nederland
TEL 0299-390111 FAX 0299-390114

Australia

Bose Australia, Inc., 1 Sorrell Street
Parramatta, N.S.W. 2150
TEL 02 204-6111 FAX 02 204-6122

Belgique/België

Bose N.V., Limesweg 2, B-3700 Tongeren
TEL 012-390800 FAX 012-390840

Danmark

Bose A/S, Industrivej 7, 2605 Brøndby
TEL 4343-7777 FAX 4343-7818

Deutschland

Bose GmbH, Max-Planck-Straße 36d
D-61381 Friedrichsdorf
TEL 06172-71040 FAX 06172-710419

France

Bose S.A., 6, rue Saint Vincent
78100 Saint Germain en Laye
TEL 01-30616363 FAX 01-30614105

India

Bose Corporation India Private Limited
W-16, Greater Kailash-II
New Delhi 110 048
TEL (011) 648 4462 FAX (011) 648 4463

Ireland

Bose Corporation
Carrickmacross, Co Monaghan
TEL 042-61988 FAX 042-61998

Italia

Bose S.p.A., Via della Magliana 876
00148 Roma
TEL 06-65670802 FAX 06-65680167

Japan

Bose K.K., Shibuya YT Building
28-3 Maruyama-cho
Shibuya-ku, Tokyo 150
TEL 3-5489-0955 FAX 3-5489-0592

Nederland

Bose B.V., Nijverheidstraat 8
1135 GE Edam
TEL 0299-390111 FAX 0299-390109

Norge

Bose A/S, Solheimsgate 11
N-2001, Lillestrøm
TEL 63-817380 FAX 63-810819

Österreich

Bose Ges.m.b.H., Vienna Business Park
Wienerbergstrasse 7 (10.OG)
A-1100 Vienna
TEL 01-60404340 FAX 01-604043423

Schweiz

Bose AG, Rünenbergerstrasse 13
4460-Gelterkinden
TEL 061-9815544 FAX 061-9815502

Sverige

Bose A/S, JohanneFredsgatan 4
S-43153 Mölndal
TEL 31-878850 FAX 31-274891

United Kingdom

Bose Limited, Unit G2
Trinity Trading Estate
Sittingbourne, Kent ME10 2PD
TEL 01795-475341 FAX 01795-427227

From other locations

Bose Customer Service, 1 New York Ave.
Framingham, MA 01701-9168 USA
TEL (508) 766-1900 FAX (508) 766-1919

World Wide Web

www.bose.com



BOSE[®]
Better sound through research[®]

©1999 Bose Corporation
The Mountain, Framingham, MA 01701-9168 USA
189858 AM Rev.03 JN 00207